

Reddy[®]

User's Guide



© Eddyfi NDT, Inc.

2800 Louis-Lumière Street, Suite 100
Québec (QC)
G1P 0A4 CANADA

Eddyfi, Magnifi, Reddy, and their associated logos are trademarks or registered trademarks of Eddyfi NDT, Inc. Eddyfi reserves itself the right to change product offerings and specifications without notice.

2017-07-18

Contents

General Precautions and Conventions

General Precautions.....	xi
Safety Precautions.....	xi
Conventions.....	xii
EMC Directive Compliance.....	xiii
Calibration and Warranty Seals.....	xiii
Limited Warranty.....	xiv
Copyrights.....	xiv

Chapter 1 Reddy Overview

Introducing Reddy®.....	3
Positioning Reddy.....	8
Starting Reddy.....	9
Shutting Down Reddy.....	9
Connecting Probes.....	10
Batteries.....	10

Chapter 2 MagnifiGO Overview

Introducing Magnifi®GO.....	15
-----------------------------	----

Chapter 3 Preferences

Managing Preferences.....	23
---------------------------	----

Chapter 4 Keypad and Keyboard Functions

Keyboard Shortcut Keys.....	27
-----------------------------	----

Chapter 5 Using Reddy with Sharck Probes

Introduction.....	29
Tangential Eddy Current Array Technology.....	30
Getting Ready.....	32
Setting Up Your Inspection.....	34
Analyzing Data.....	42
Saving and Reporting.....	46

Chapter 6 Maintenance and Troubleshooting

Maintaining Reddy®.....	49
Updating and Upgrading Magnifi®GO.....	49
Troubleshooting.....	51

Chapter 7 Specifications

General.....	53
Environmental.....	53
ECA.....	53
ECT.....	54

Appendix A Connector Reference

ECA Connector (160 pins).....	57
ECT Connector (19 pins).....	57
I/O Connector (12 pins).....	57
Ethernet Connector.....	58
HDMI Connector.....	58
USB Connectors.....	59
3.5 mm Audio Connector.....	59

Appendix B Using the Optional Harness

Adjusting the Harness.....	61
----------------------------	----

Figures

Figure 1–1 Reddy in the horizontal position.....	8
Figure 1–2 Reddy in the tilted position.....	8
Figure 1–3 Shutting down Reddy.....	9
Figure 1–4 Optional battery charger.....	12
Figure 2–1 Front-stage view.....	16
Figure 2–2 Strip chart.....	17
Figure 2–3 Lissajous.....	17
Figure 2–4 C-scan.....	18
Figure 2–5 Project.....	19
Figure 2–6 Acquisition Summary.....	20
Figure 2–7 Report Summary.....	20
Figure 2–8 Save.....	21
Figure 2–9 Material Database.....	21
Figure 3–1 General preferences.....	23
Figure 3–2 Display preferences.....	23
Figure 3–3 Analysis preferences.....	24
Figure 3–4 Help.....	24
Figure 5–1 Medium Shark probe.....	29
Figure 5–2 Removable Sharck encoder and guiding wheels.....	29
Figure 5–3 Simplified TECA working principles.....	30
Figure 5–4 Typical signal signature.....	30
Figure 5–5 Effects of compensation to liftoff on detected 5 mm deep defect with 0, 1, 2 mm liftoffs.....	30
.....	30
Figure 5–6 Integrated 3D depth plane to correlate crack depth, vertical amplitude, and liftoff.....	31
Figure 5–7 Example data before/after adjusting User Mat	31
Figure 5–8 Backstage view: Create/Open inspection.....	32
Figure 5–9 Creating an inspection project.....	32
Figure 5–10 Acquisition Summary dialog box.....	33
Figure 5–11 Backstage view: Create/Open setup.....	33
Figure 5–12 Open Setup dialog box.....	34
Figure 5–13 Verifying the applied setup.....	34

Figure 5–14 Component definition.....	35
Figure 5–15 Probe selection.....	35
Figure 5–16 Scan definition: configure scan.....	35
Figure 5–17 Scan definition: configure encoder and start position.....	36
Figure 5–18 Data definition: configuring filters.....	36
Figure 5–19 Indication codes.....	37
Figure 5–20 Display properties.....	37
Figure 5–21 Display layout.....	37
Figure 5–22 Nulling the Sharck probe.....	38
Figure 5–23 Sharck Assisted Calibration.....	38
Figure 5–24 Sharck Assisted Calibration: Calibration complete.....	39
Figure 5–25 Sharck probe on carbon steel weld.....	40
Figure 5–26 Probe origin and defect positioning along the scanning axis (probe shown top view).....	40
Figure 5–27 Disabled functions during acquisition.....	41
Figure 5–28 Saving data.....	41
Figure 5–29 Flaw-like and spurious indications.....	42
Figure 5–30 Sizing information.....	43
Figure 5–31 Take screen captures with defect report entry check box.....	43
Figure 5–32 Selecting a layout.....	43
Figure 5–33 Entering a detected defect.....	44
Figure 5–34 Measurement methods.....	44
Figure 5–35 Report tab.....	45
Figure 5–36 Transverse C-scan.....	45
Figure 5–37 Report summary.....	46
Figure 5–38 Report options.....	46
Figure 5–39 Report summary.....	47
Figure 5–40 Inspection report.....	47
Figure 6–1 Options menu.....	50
Figure 6–2 System recovery interface.....	50
Figure B–1 Slipping the harness on.....	61
Figure B–2 Adjusting the shoulder straps.....	62
Figure B–3 Adjusting the belt’s height.....	62

Figure B–4 Securing the chest straps.....	62
Figure B–5 Securing the belt.....	63
Figure B–6 Shoulder anchor straps.....	63
Figure B–7 Unfastening the straps.....	64
Figure B–8 Sliding strap loop through bumper hook.....	64
Figure B–9 Securing anchor strap.....	64
Figure B–10 Alternative method of securing anchor strap to bumper.....	65
Figure B–11 Anchor strap on harness belt.....	65
Figure B–12 Slipping male buckle through bumper.....	65
Figure B–13 Mating battery compartment side anchor strap.....	66
Figure B–14 Closing battery compartment door.....	66
Figure B–15 Mating shoulder anchor strap.....	66
Figure B–16 Tightening shoulder anchor straps.....	67
Figure B–17 Belt-slinging probe cable.....	67

Tables

Table 2–1 Multi-touch behavior in the strip chart view.....	18
Table 2–2 Multi-touch behavior in the Lissajous view.....	18
Table 2–3 Multi-touch behavior in the C-scan view.....	19
Table 4–1 Keyboard shortcut keys.....	27
Table 7–1 General specifications.....	53
Table 7–2 Environmental specifications.....	53
Table 7–3 Eddy current array specifications.....	53
Table 7–4 Eddy current testing specifications.....	54
Table A–1 ECT connector data.....	57
Table A–2 ECT connector pinout.....	57
Table A–3 I/O connector data.....	57
Table A–4 I/O connector pinout.....	58
Table A–5 Ethernet connector data.....	58
Table A–6 Ethernet connector pinout.....	58
Table A–7 HDMI connector data.....	58
Table A–8 HDMI connector pinout.....	59
Table A–9 USB connector data.....	59
Table A–10 USB connector pinout.....	59
Table A–11 Audio connector data.....	59
Table A–12 Audio connector pinout.....	59

General Precautions and Conventions

General Precautions

The following safety precautions are to be observed at all times when using Reddy®. Make sure that you review them **before** turning on the system.

- Keep this document in a safe place for future reference.
- Carefully follow the installation and operation procedures detailed herein.
- Respect the safety warnings on the instrument and in this document.
- Reddy should only be used by qualified personnel.
- When transporting Reddy, it is your responsibility to make sure that you apply the safety precautions dictated by the relevant local governing bodies.
- Always connect the power supply to a properly grounded receptacle, extension cord, or power bar. Grounding a single conductor of a two-conductor outlet is not sufficient protection for Reddy.
- Only connect the system to a power source corresponding to the type indicated on the rating plate.
- If you use the system in a manner that deviates from that specified by Eddyfi, the protection provided on the equipment may be rendered null and void.
- Do not use substitute parts or perform unauthorized modifications to the system.
- Service instructions, when applicable, are intended for trained service personnel only.
- Always make sure that the system is unplugged from any power supply before servicing.
- To avoid dangerous electric shock, do not perform any service on the system unless qualified to do so. If you encounter any problems or have questions regarding this system, contact Eddyfi or an authorized Eddyfi representative.

Safety Precautions

Observe the following safety precautions scrupulously when using Reddy.

Rear Stand

Because Reddy is a portable system, it is designed to be used under tough conditions. It is, however, not indestructible. To avoid damaging Reddy, use its rear stand when operating Reddy in a tilted position. Do not use Reddy in the upright position, as it may topple over or fall off the work surface.

Conventions

Typographical

The following typographical conventions are used throughout this document:

Italic

Used for file names and paths.

Bold

Used to indicate menu items, named user interfaces, and place emphasis on specific words or phrases. Items in bold type are capitalized to reflect the actual interface.

SMALL CAPITALS

Used to indicate instrument interface indications.

Marking and Symbols

The following symbols appear on the instrument and pertain to safety regulations that should be carefully observed:



This label is used as a general warning sign. It indicates that you should refer to this user's guide to obtain the necessary information for proper protection of the instrument and its users.



This label is used to indicate high voltage. It draws your attention to the presence of hazardous voltages (within the product enclosure or accessible externally) that may constitute a risk of electric shock to persons. Always refer to the user's guide to ensure proper protection and safety.



The RoHS compliance logo signifies that this product complies with the Restriction of Hazardous Substances directive 2002/95/EC. This directive restricts the use of lead, mercury, cadmium, hexavalent chromium, polybrominated biphenyl, and polybrominated diphenyl ether in certain classes of electrical and electronic units as of July 1, 2006.



This label acts as a reminder that you should dispose of this system in accordance with your local Waste Electrical and Electronic Equipment (WEEE) regulations. This system was manufactured to the high quality standards of Eddyfi to ensure safe and reliable operation when it is used as stated in this document. Due to its nature, this instrument may contain small quantities of substances known to be hazardous to the environment and to human health if released in the environment. As such, systems falling under WEEE regulations should not be disposed of in the public waste stream.

Safety Indications in This Document

The safety indications in this document are intended to ensure your safety and the integrity of the system.

Warning



The warning indication calls your attention to a procedure or a practice (or the like) that, if performed incorrectly, can result in injury. Do not ignore warning indications — make sure that you understand the condition before proceeding.

Caution



The caution indication calls your attention to a procedure or practice (or the like) that, if performed incorrectly, can result in material damage, loss of data, or both. Do not ignore caution indications — make sure that you understand the condition before proceeding.

Important

Calls attention to information important to completing tasks.

Note

Calls attention to an operating procedure, a practice, or the like that requires special attention. Notes also indicate useful related, but parenthetical information that is unessential.

EMC Directive Compliance

FCC Compliance (USA)

This equipment was tested and found to comply with the limits for a Class A digital device, pursuant Part 15 of the FCC Rules. These limits are designed to provide reasonable protection against harmful interference when the equipment is operated in a commercial environment. This equipment generates, uses, and can radiate radio frequency energy and, if not installed and used in accordance with the user's guide, may cause harmful interference to radio communications. Operation of this equipment in a residential area is likely to cause harmful interference in which case you will be required to correct the interference at your own expense.

ICES Compliance (Canada)

This ISM device complies with Canadian ICES-001.

Cet appareil ISM est conforme à la norme NMB-001 du Canada.

AS/NZS Compliance (Australia/New Zealand)

This device complies with Australia and New Zealand AS/NZS 4252.2 (IEC 61000-6-4) and AS/NZS 61000-6-2 (IEC 61000-6-2).

Calibration and Warranty Seals

The calibration seal is at the back of the instrument. Reddy is also equipped with a warranty seal.

Important

Broken seals void the calibration certification and product warranty.

Limited Warranty

Eddyfi NDT, Inc. warrants the hardware to be free of any defects in materials or workmanship for a period of twelve (12) months from the date of delivery, under normal use and service. These warranties are limited to the original purchase of the product and are not transferable.

Eddyfi NDT, Inc. will repair or replace any product component or documentation, at its option and at no additional charge, if found defective within the warranty period. The purchaser is responsible for returning the product to Eddyfi NDT, Inc.

Eddyfi NDT, Inc., will not be held responsible in any way whatsoever for damage resulting from improper installation, accident, misuse, or from service or modification of the product by anyone other than Eddyfi NDT, Inc., or an authorized Eddyfi NDT, Inc. service center.

Eddyfi NDT, Inc. will not be held responsible in any way whatsoever for direct, indirect, special, incidental, or consequential damages resulting from possession, use, improper installation, accident, service, modification, or malfunction of the product (including, without limitation, damages for loss of business profits, business interruption, loss of business information, or other pecuniary loss). Eddyfi's total shall in no event exceed the purchase price of the applicable item(s).

This warranty is in lieu of all other warranties, whether oral, written, expressed, or implied, including any warranty of merchantability or fitness for a particular purpose, and no other representation or claims of any nature shall be binding on or obligate Eddyfi NDT, Inc.

This agreement is governed by the laws of the province of Québec, Canada. Each of the parties hereto irrevocably attorns to the jurisdiction of the courts of the province of Québec and further agrees to commence any litigation which may arise hereunder in the courts located in the judicial district of Québec.

Copyrights

This document and the product and programs it describes are protected by the Copyright Act of Canada, by laws of other countries, and by international treaties, therefore may not be reproduced, in whole or in part, whether for sale or not, without prior written consent from Eddyfi NDT, Inc. Under copyright law, copying includes translation in other languages and formats.

© Eddyfi NDT, Inc., 2015

This document was prepared with particular attention to usage to ensure the accuracy of the information it contains. It corresponds to the version of the product manufactured prior to the date appearing on the back cover. There may, however, be some differences between this document and the product, if the product was modified after publication.

The information contained in this document is subject to change without notice.

First edition, June 2015

Chapter 1

Reddy Overview

Introducing Reddy®

Thank you for purchasing Eddyfi's Reddy. This chapter is intended to give you an overview of the system and its components before operation.

What's in the Box

Reddy comes with the following standard accessories:

- Two, high-capacity batteries
- One power adapter (100–240 V)
- Power cords (one for North America, one for Europe)
- DVD containing the user's guide
- Stylus
- Transport case

Instrument Overview

Front

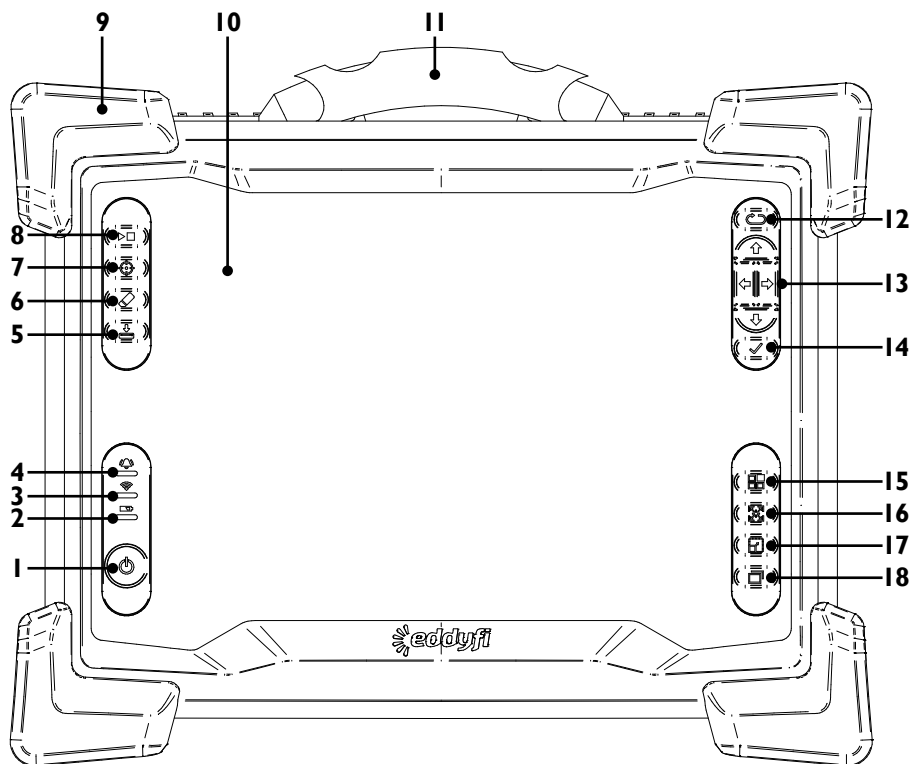

1. Power button

Use this button to turn the instrument on and off. The power indicator at the center of the button behaves as follows:

- Green: Reddy is on
- Blinking yellow/orange: Reddy is on standby
- Unlit: Reddy is off

2. Battery indicator

This indicator displays the state of Reddy's batteries when the instrument is on. Depending on the power mode (DC or battery), the indicator behaves differently:

DC power

- Green: batteries fully charged
- Blinking green: batteries charging
- Red: battery or charger error
- Unlit: no batteries in Reddy

Battery power

- Unlit: remaining charge over 40%
- Orange: remaining charge 20–40%
- Blinking yellow: remaining charge less than 20%
- Red: battery error

3. Wi-Fi indicator

This indicator displays the Wi-Fi status. When the indicator is lit, the Reddy Wi-Fi is enabled. When it is off, the Wi-Fi is disabled.

4. Alarm indicator

This indicator is used to display user-programmed errors. The indicator remains unlit until it detects a predefined error condition, at which time it lights red.

5. Save inspection data button

Press this button to save the current inspection data according to the defined file naming scheme on the internal SSD. See page 15.

6. Clear active Lissajous button

Press this button to clear the currently active Lissajous display on the screen.

7. Probe nulling button

Press this button to null the probe currently connected to Reddy.

8. Start/Stop acquisition button

Press this button to start or stop data acquisition.

9. Heavy-duty bumpers

The four corner bumpers provide shock absorption and support Reddy at an angle when it is set on a flat surface. The bumpers are also hooked for harnessing. For details about harnessing, see page 61.

10. Multi-touch display

10.4", non-reflective, backlit, high-resolution display.

11. Handle

Use this handle when carrying Reddy.

12. Keypad arrow mode selection button

Use this button to select the operation mode of the keypad arrows (13).

13. Keypad arrows

Use these arrows to navigate the Magnifi GO interface according to the selected mode.

14. Enter button

Unused at this time.

15. Change active view button

Press this button to activate a different view than the one currently active.

16. Data display button

Use this button to center or best fit the data on the Reddy screen. A short press centers data on the screen, while a long press fits the data.

17. Maximize/Minimize view button

Use this button to maximize or minimize the active view.

18. Change layout button

Use this button to change the Magnifi GO layout to another predefined layout.

Right

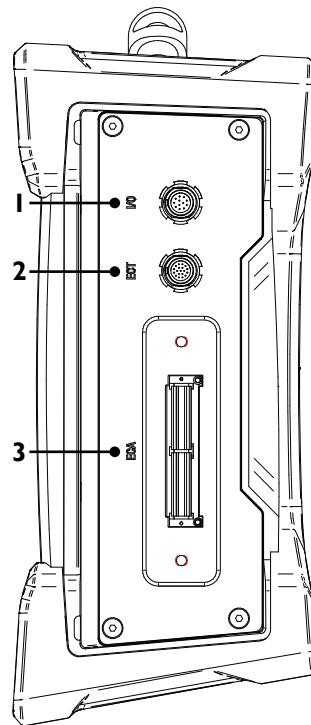

1. I/O connector

Use this connector to communicate with the probe's encoder, for example. See page 10 for details.

2. ECT connector

Connect your eddy current testing probes to this connector. See page 10 for details.

3. ECA connector

Connect your eddy current array probe such as the Sharck™ probe to this connector. See page 10 for details.

Left

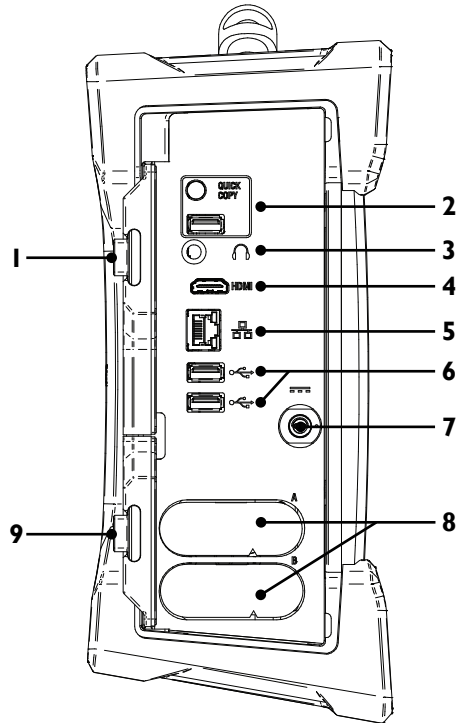

1. Protective connector door

Protects the Reddy's powerful connectivity from the elements when they are not in use.

2. QUICK COPY

Use the QUICK COPY button to transfer all your inspection data to a USB mass storage device. This allows you to transfer this data easily.

3. Audio connector

Use this connector to hook up a headset to Reddy.

4. HDMI® connector

Use this connector to hook up an external monitor to Reddy.

5. Network connector

Use this connector to hook up Reddy to a local area network (LAN). This connector is equipped with two indicators with the following behavior:

Connection indicator (upper)

- Green: communication established between Reddy and the network
- Blinking green: activity between Reddy and the network
- Unlit: no link to network

Connection speed indicator (lower)

- Amber: operating as a gigabit connection (1 Gbps)
- Green: operating as a 100 Mbps connection
- Off: operating as a 10Mbps connection

6. USB 2.0 connectors

Use these connectors to hook up USB devices to Reddy such as a mouse or external disk drive.

7. Power connector

Use the supplied power cord to operate Reddy and recharge the batteries.

8. Battery compartments

Insert the supplied batteries into the appropriate battery compartment. For details about batteries, see page 10.

9. Protective battery compartment door

Protects the battery compartments from the elements.

Rear

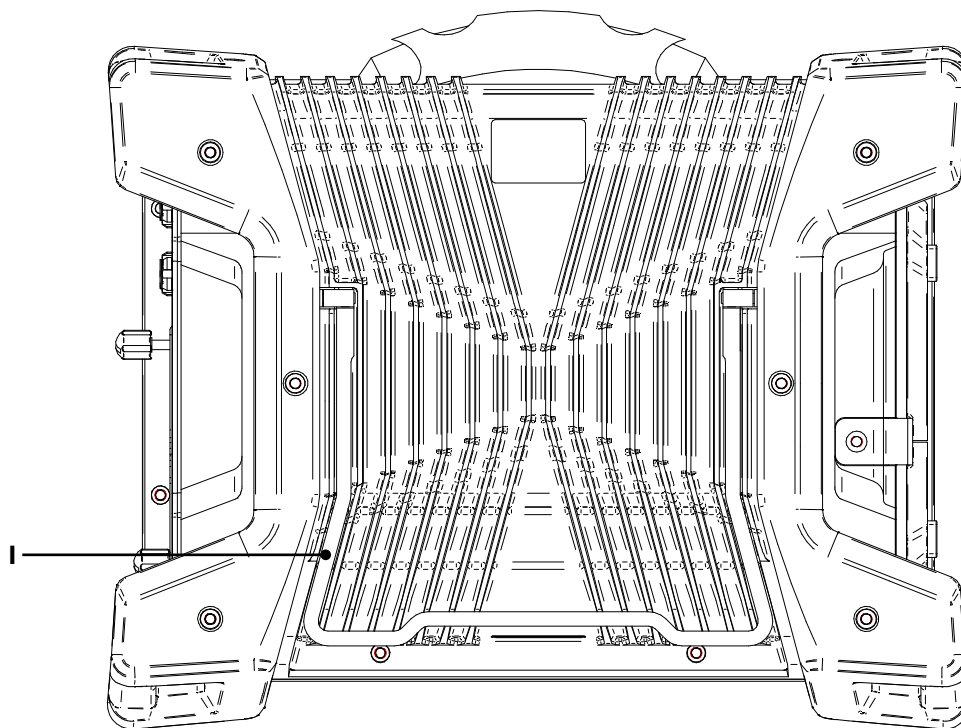

I. Instrument stand

This stand retracts outward to hold Reddy at an angle, preventing the instrument from falling over horizontally.

Positioning Reddy

Reddy must be properly positioned prior to use so that you do not run the risk of dropping the instrument or the instrument falling over. Reddy has **two** safe operating positions: horizontal and tilted. To use Reddy in a tilted position, simply pull out the stand located at the rear of the instrument until Reddy is at the desired angle. If you are using Reddy with the optional harness, see *Using the Optional Harness* on page 60 for details.

Figure I-1 Reddy in the horizontal position

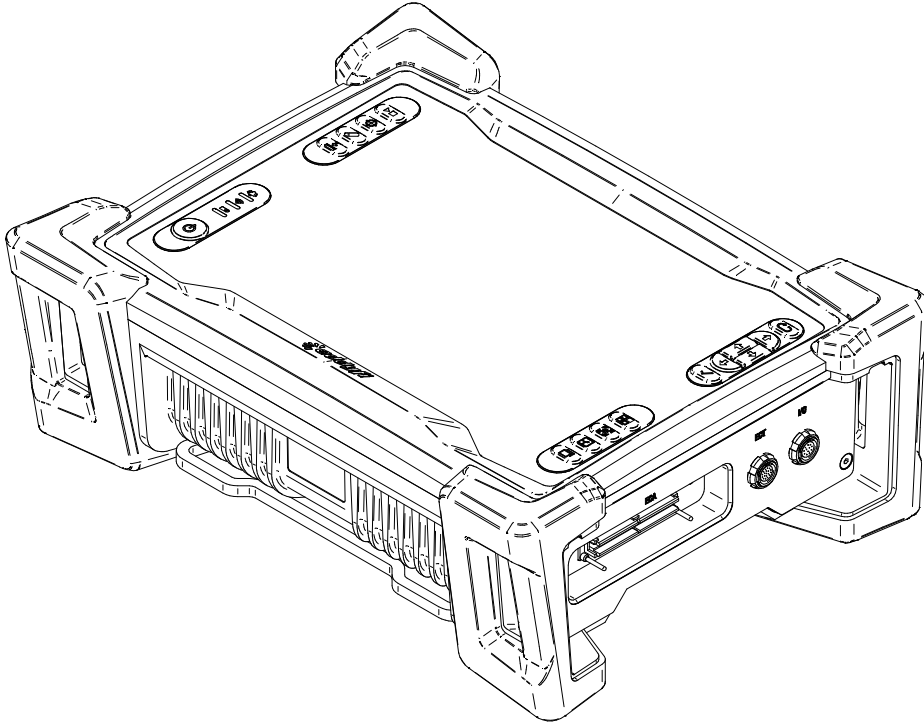
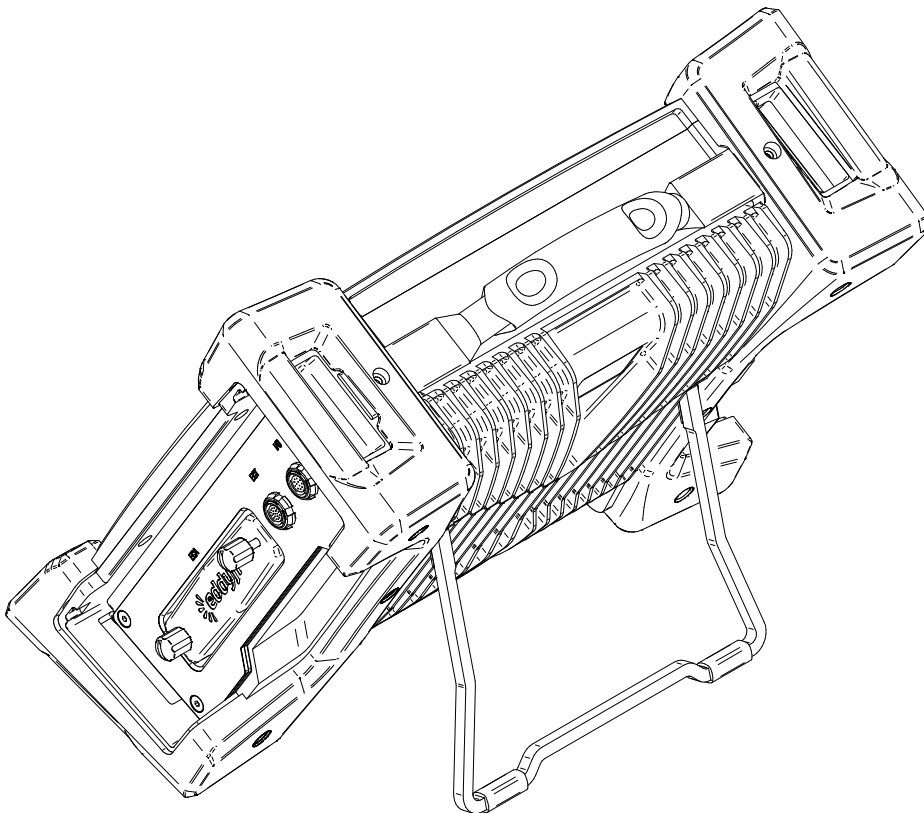

Figure I-2 Reddy in the tilted position





Caution

It is possible to use Reddy while it rests on its lower bumpers, but this is **not a safe operational position** as the instrument may fall over. If you want to use Reddy at an angle, use the stand located at the rear of the instrument.

Important

Regardless of how you position the instrument, you must always have a minimum clearance of 10 cm (4 in) on all sides of the instrument. Always position the instrument away from heat sources. This ensures proper heat dissipation while the instrument is in use.

Starting Reddy

Proceed as follows to turn on your instrument or exit the standby mode:

1. Make sure that at least one of the two batteries is inserted into battery compartment A of the instrument or that the instrument is plugged to an external power source using the supplied power cord.
2. Press the power button.
The power indicator at the center of the power button lights green.

Shutting Down Reddy

Proceed as follows to shut down your instrument:

1. Save all your data.
2. Press the power button.
Three option buttons appear on the display.

Figure I-3 Shutting down Reddy

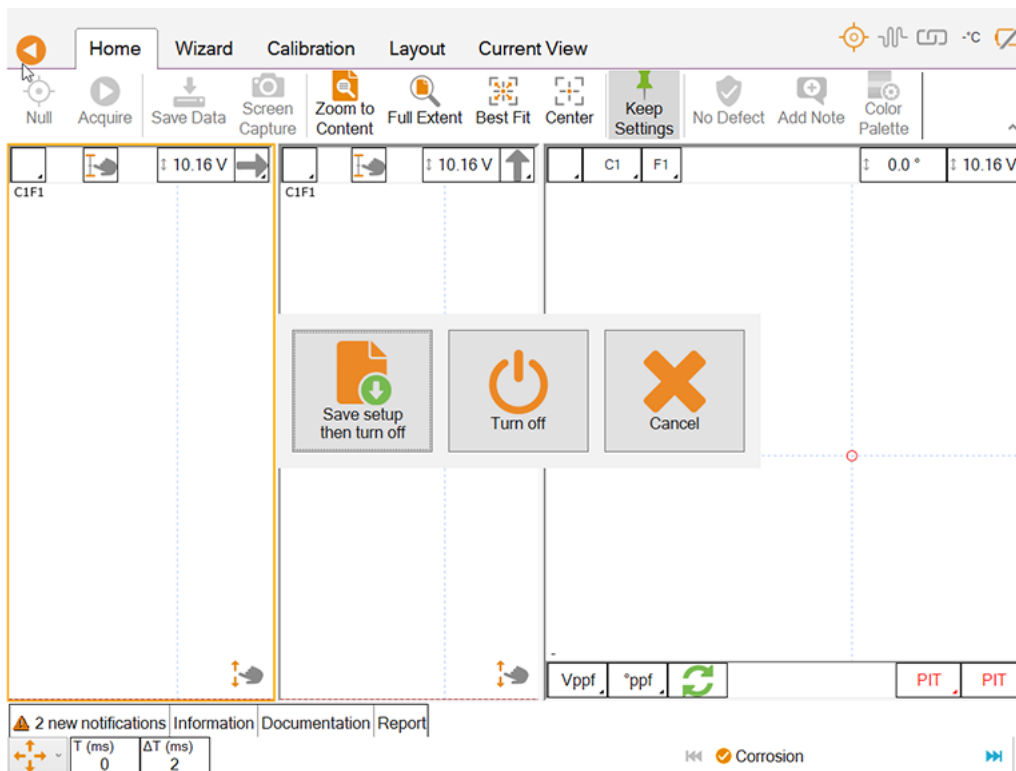

3. Tap the button of your choice.
The instrument shuts down.

Connecting Probes

Connecting an ECA Probe

Eddyfi ECA probes come in several models: Sharck, I-Flex™, etc. These probes hook up to Reddy's array connector. Proceed as follows to do so:

1. If you have not already done so, remove Reddy from its carrying case and place it on your working surface as outlined in *Positioning Reddy* on page 8.
2. If you have not already done so, remove the protective caps from the ECA and I/O connectors.
3. Align the probe's connector with the ECA connector on the instrument.

Hint

The Eddyfi logo on the probe's connector should be facing you when you face the instrument.

4. Thoroughly insert the probe's connector into the ECA connector.
5. Secure the probe's connector with its two screws.
6. Align the probe's 12-pin male encoder connector with the I/O connector on the instrument.

Hint

The alignment mark on the connector should be facing you when you face the instrument.

7. Push the connector until you hear it click.

Connecting an ECT Probe

ECT probes such as pencil probes hook up to Reddy's ECT connector. Proceed as follows to do so:

1. If you have not already done so, remove Reddy from its carrying case and place it on your working surface as outlined in *Positioning Reddy* on page 8.
2. If you have not already done so, remove the protective cap from the ECT connector.
3. Align the probe's connector pins with the ECT connector on the instrument.

Hint

The alignment mark on the probe's connector should be facing you when you face the instrument.

4. Push the connector until you hear it click.

Batteries

Reddy can be used under battery power. The instrument is designed with two battery cradles under the protective battery compartment door, but can be powered by a single battery. Reddy uses Li204SX-7800 lithium-ion rechargeable batteries from Emerging Power, which do not suffer from the memory effect affecting previous generations of batteries.



Warning

Whenever carrying Reddy in its transport case, remove the batteries from the instrument and make sure that they cannot come in contact during transport, as this poses a significant fire and explosion hazard.

When carrying Reddy, it is the user's responsibility to make sure that the safety precautions used are in accordance with the local department of transportation (or equivalent governing body) rules and regulations.

Reddy's transport case comes with two slots, fitted to receive the batteries when removed from the instrument.

Note

Make sure that you do not replace the batteries by batteries other than Li204X-7800 lithium-ion rechargeable batteries from Emerging Power. Contact your Eddyfi representative for more information about pricing and availability or replacement batteries.

Inserting/Removing Batteries

Inserting Batteries

1. On Reddy's left side, unlatch the battery compartment's door, and then open it.
2. Align your battery with one of the battery cradles.

Note

Battery cradles are marked A and B. If you are inserting only one battery, it does not matter which of the two cradles you use.

3. Make sure that the battery contacts are facing inward and upward.
4. Slide the battery into the battery cradle until it is fully inserted.
You should feel the battery contacts snap into place.

Removing Batteries

1. On Reddy's left side, unlatch the battery compartment's door, and then open it.
2. Grab the battery tab between thumb and forefinger.
3. Pull on the tab.

You will feel the battery contacts being released.

4. Slide the battery out of its cradle.

Hot Swapping Batteries

You can remove one of Reddy's batteries when the instrument is turned on as Reddy can operate with a single battery. Should the power in the remaining battery be insufficient to keep Reddy operating, the instrument shuts down without damaging electronic components, but all your work in progress in MagnifiGO (acquisition, etc.) is lost.

Charging Batteries

Normally, Reddy's batteries recharge automatically when they are in the instrument, it is connected to a power outlet and turned on. The charge indicator on the lower-left keypad displays some information about the battery charge (see page 3). MagnifiGO also features a battery charge indicator (see page 16).

Note

Batteries do not recharge when their internal temperature exceeds 45 °C (113 °F). Batteries also do not power Reddy when the instrument's internal temperature exceeds 55 °C (131 °F).

Using the Optional Battery Charger

An optional battery charger is available from Eddyfi. Contact your Eddyfi representative for more information about pricing and availability. This charger conditions and calibrates the instrument's batteries, which is important to maximize their lives. We recommend calibrating the batteries every six months.

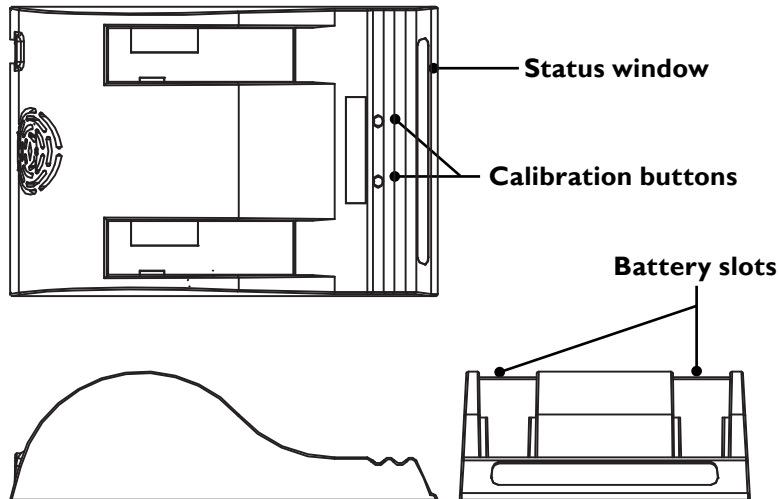
Figure I-4 Optional battery charger

To charge the batteries with the optional charger:

1. Place the charger on a flat and level surface, away from heat and moisture sources.
2. Insert the power supply's DC connector into the back of the external charger.
3. Connect the power supply to an AC supply using the supplied cable.
All the LEDs flash momentarily to let you know that power is present.
4. Insert the batteries into the battery slots while making sure that the contacts are fully seated.
The charger automatically begins charging the batteries and the LEDs in the status window display the following information:
 - Blinking green: battery charging
 - Green: battery fully charged
 - Blinking blue: battery calibrating
 - Blue: battery charge gauge calibrated
 - Blinking red: battery charge gauge in need of calibration
 - Red: error

Calibrating Batteries

To ensure that your batteries perform at their full capacity for the longest possible time, it is important to calibrate them on a regular basis. Calibration involves a standard battery charge followed by a deep discharge, and then a complete charge. This procedure usually takes 10 to 13 hours, whereas a standard charge only takes approximately 3.5 hours.

Calibrate batteries by placing them in the optional charger and then pressing the calibration button. We recommend calibrating your batteries at least every six months.

Storing Batteries

Whenever transporting Reddy in its case, **remove the batteries** from the instrument and make sure that they **cannot come in contact** during transport, as this is a significant fire and explosion hazard.

Reddy's transport case is outfitted with two slots intended for the batteries. We recommend that you take advantage of them.

Chapter 2

Magnifi GO Overview

Introducing Magnifi® GO

Magnifi GO is the software running on Reddy®. It is a powerful and easy-to-use acquisition and analysis software especially designed for surface inspection and relies on intuitive wizards to configure setups.

Magnifi GO has a graphical user interface (GUI) designed to simplify the inspection process and enhance your experience. The multi-touch display is the best way of interacting with Magnifi GO, but you can also use a USB mouse and keyboard.

Through the GUI, all the functions associated to **inspection project management**, the **global settings**, and the **preferences** are in what is referred to as the *backstage view*. All **inspection work**, **calibration**, **acquisition**, and **analysis** is in what is referred to as the *front-stage view*. This is how Magnifi GO offers a streamlined and coherent interface that makes the learning process easy.

Note

MagnifiSR: This version of the Magnifi software allows you to perform advanced analysis of the data acquired with Reddy directly on your computer. Magnifi SR offers the same graphical user interface than Magnifi GO so any analyst can be up and running in next to no time, with a wider range of large monitor data layouts than Magnifi GO. This means that Reddy units can be out acquiring data in the field while analysts are hard at work on their computers extracting value from the data. Furthermore, with MagnifiSR you can easily plan and set up inspections for several Reddy instruments to make the most of your hardware.

Backstage Overview

The backstage view is composed of seven sections that supply different information.

Project Section

The default section and first section of the backstage view is the **Project** section, which contains information about:

- Probe currently connected to Reddy
- Inspection and currently loaded setup
- File naming prefix
- Automatic screen capture option

This is where you:

- Create a setup
- Open an existing setup
- Create an inspection
- Open an existing inspection
- Generate a report
- Import an existing inspection from an external USB mass storage device

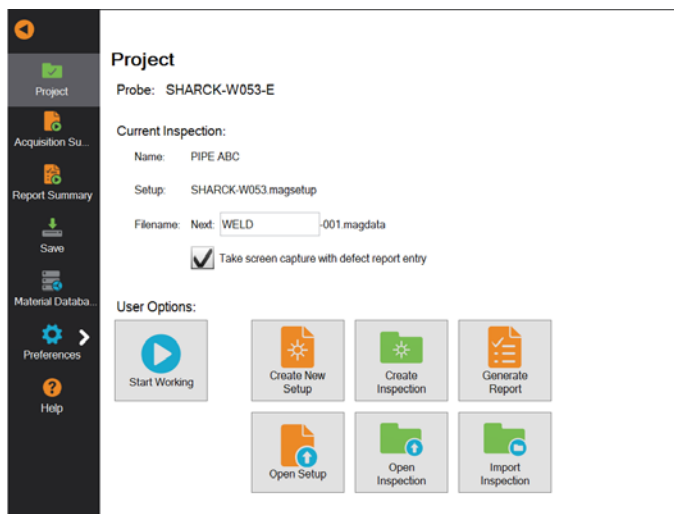

Under most circumstances, this is the only section that you'll need to manage inspection projects.

Other sections are described below.

Front Stage Overview

The front stage displays all the information about your current inspection. This is where you will find all the tools to acquire, save, and analyze inspection data.

Figure 2-1 Front-stage view



1. Backstage icon

Tap this button to access the backstage view.

2. Ribbon-style menus

These five menus allow you to perform several inspection operations. Read on for details.

3. Status icons

These icons convey unit status information graphically. Continue reading for details.

4. Data display area

This area is where you see the inspection data.

5. File navigator

Use the file navigator to display inspection results in the data display area.

6. Information

This area displays information according to the tab selected in 8.

7. Keypad arrow mode selector

Tap this icon to change the operational mode of the keypad arrows. See chapter 1 for details.

8. Information tabs

Tap the tabs to display position information, documentation information, or report information. Continue reading for details.

Views

Views vary according to the type of probe you are using. You can select layouts or set one up yourself. This section introduces the various elements of available views.

Strip Chart View

Figure 2-2 Strip chart

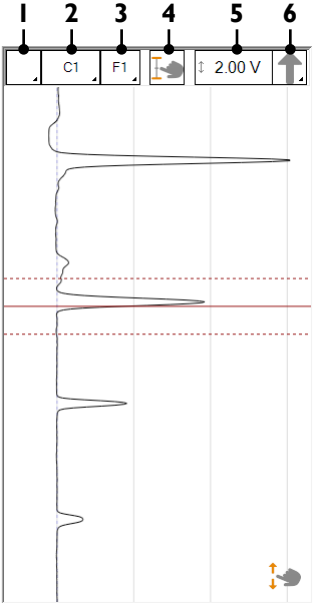

- 1. Global channel/C-scan selector
- 2. Channel/C-scan group name and selector
- 3. Frequency selector
- 4. Resize cursor
- 5. Scale
- 6. Signal component selector

Lissajous View

Figure 2-3 Lissajous

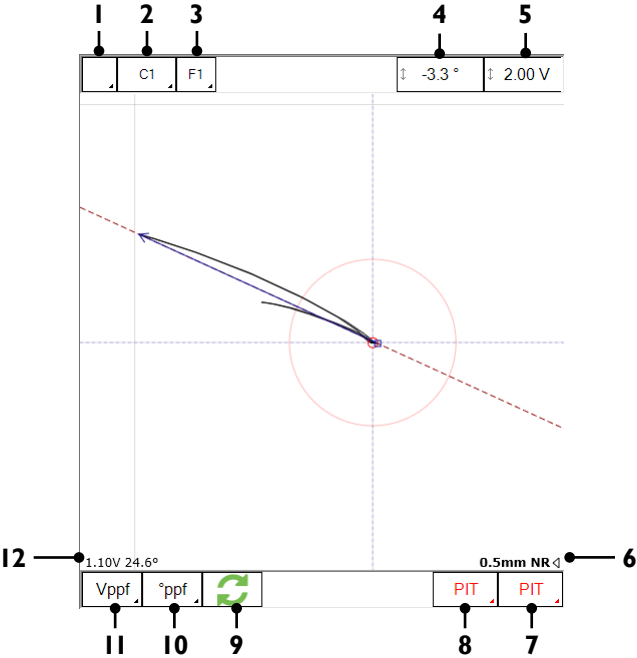

- 1. Global channel/C-scan selector
- 2. Channel/C-scan group name and selector
- 3. Frequency selector
- 4. Rotate (on/off toggle)
- 5. Scale
- 6. Sizing measurement (when sizing curve created)
- 7. Report code 1
- 8. Report code 2
- 9. Invert phase angle measurement
- 10. Phase angle measurement mode
- 11. Amplitude measurement mode
- 12. Signal measurement result

C-Scan View

Figure 2-4 C-scan

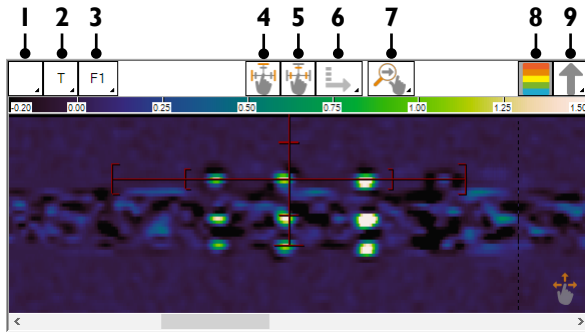

1. **Global channel/C-scan selector**
2. **Channel/C-scan group name and selector**
3. **Frequency selector**
4. **Resize cursor button (toggle behavior)**
5. **Resize mini-cursor (toggle behavior, available when the mini-strip chart are active)**
6. **Component selection for Resize cursor action**
7. **Define the zoom axis when using the multi-touch pinch mode**
8. **Show/Hide color palette in the view**
9. **Signal component selector**

Multi-Touch Interface

The multi-touch interface of Reddy is designed for ease-of-use. According to your location in Magnifi GO, the multi-touch behavior changes.

The backstage view uses , dialog boxes, and setup wizards, the multi-touch behavior is standard: a short tap on an element of the GUI enables the associated function, exactly as it would at the click of a mouse.

Elsewhere, the multi-touch behavior is more elaborated. The tables below summarize the various behavior according to the view you are using.

Table 2-1 Multi-touch behavior in the strip chart view



Location	Touch	Behavior	Condition
View toolbars	Tap	List buttons: Selects the next option in list Toggles: Enables/disables option	
Data area	Touch and hold	List buttons: Displays entire options list	
	Touch and hold, move up or down	Scale: Increases/Decreases the scale	
	Tap	Moves cursor to touch position	
	Touch and move	Moves cursor in view	
	Two-finger touch, move up or down	Pans data in strip chart; same effect as scrollbar	
	Pinch-zoom in or out	Zooms in/out	

Table 2-2 Multi-touch behavior in the Lissajous view

Location	Touch	Behavior	Condition
View toolbars	Tap	List buttons: Selects the next option in list Toggles: Enables/disables option	
Data area	Touch and hold	List buttons: Displays entire options list	
	Touch and hold, move up or down	Rotation: Rotates data	
	Tap	Scale: Increases/Decreases the scale	
	Touch and move	Centers selected data in Lissajous	
	Two-finger rotation	Pans data in Lissajous	
	Pinch-zoom in or out	Rotates data in Lissajous Increases/Decreases the scale	Toggle

Table 2-3 Multi-touch behavior in the C-scan view

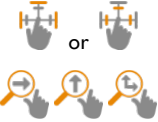
Location	Touch	Behavior	Condition
View toolbars	Tap	List buttons: Selects the next option in list Toggles: Enables/disables option	
Data area	Touch and hold	List buttons: Displays entire options list	
	Tap	Move cursor to tapped position	
	Touch and move	Move cursor in C-scan Resize the main cursor or miniature cursor along selected axis	
	Pinch-zoom in or out	Zoom in/out based according to mode	

Backstage Details

Project

Figure 2-5 Project

Project

Acquisition Su...

Report Summary

Save

Material Databa...

Preferences

Help

Project

Probe: SHARCK-W053-E

Current Inspection:

Name: PIPE ABC

Setup: SHARCK-W053.magsetup

Filename: Next: -001.magdata

Take screen capture with defect report entry

User Options:



 Start Working

 Create New Setup

 Create Inspection

 Generate Report

 Open Setup

 Open Inspection





 Import Inspection

Figure 2–6 Acquisition Summary



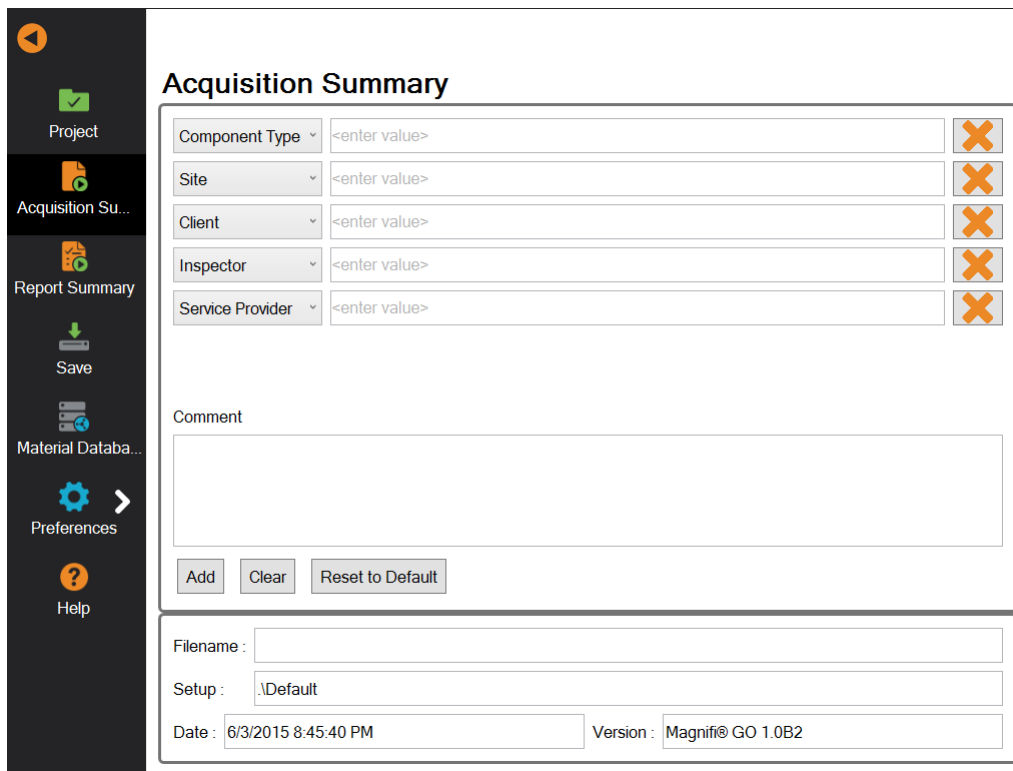

Acquisition Summary

Component Type 

Site 

Client 

Inspector 

Service Provider 

Comment

Filename :

Setup :

Date : Version :

Figure 2–7 Report Summary

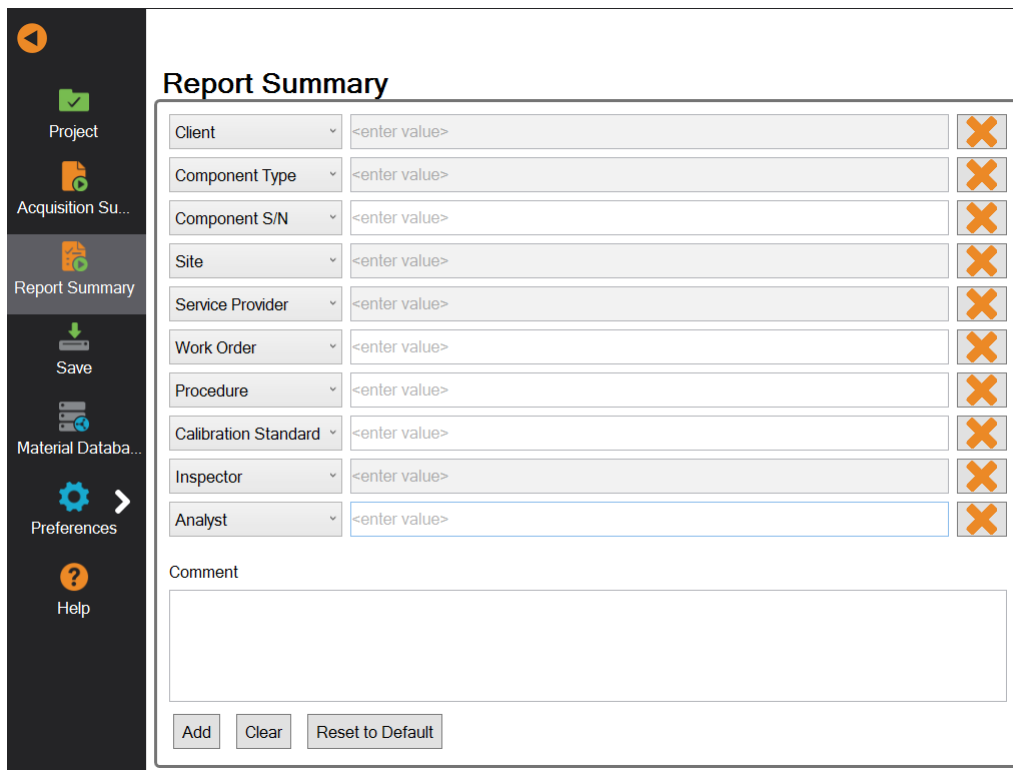



Report Summary

Client 

Component Type 

Component S/N 

Site 

Service Provider 

Work Order 

Procedure 

Calibration Standard 

Inspector 

Analyst 

Comment

Figure 2–8 Save

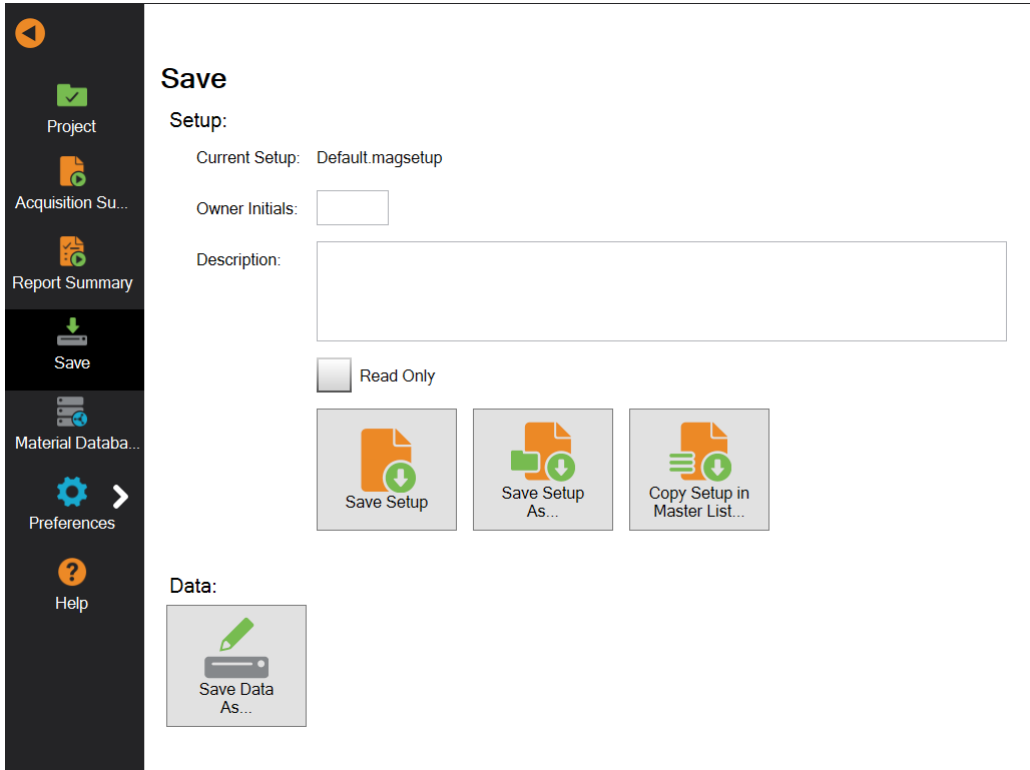
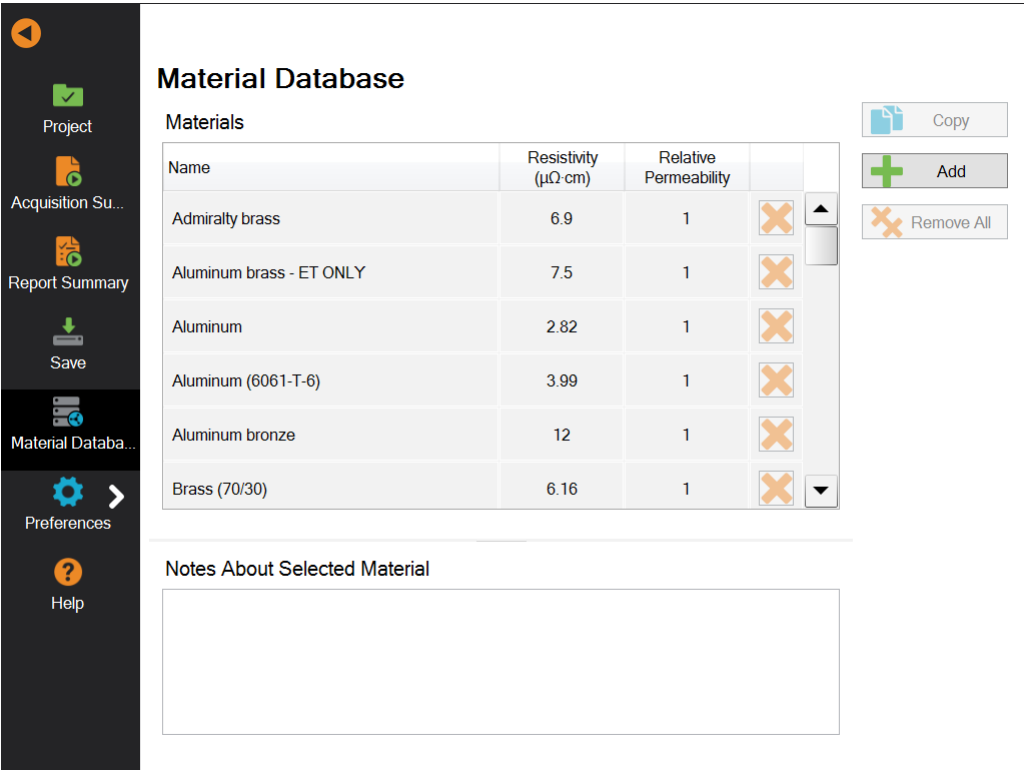

Figure 2–9 Material Database



Chapter 3

Preferences

Managing Preferences

Figure 3–1 General preferences

The screenshot shows the 'General' preferences screen. On the left is a dark sidebar with icons for 'Preferences', 'General', 'Display', and 'Analysis'. The main content area is titled 'General' and contains several sections:

- Measurement:**
 - Convention: ASME ASME Inverted EDF
 - System Units: Metric Imperial
 - Report Units: Millimeter (dropdown menu)
- Channels:**
 - Full Channel Scale: 20.00 (spinners) V p-p
 - Hide Raw Channel
- Report Options:**
 - Defect Table Profile: Shark Pencil (dropdown menu)
 - Preview: eddyfi logo
 - Select Company Logo (button)
- Date and Time:**
 - Wednesday, 03 June 2015 20:49:41
 - Change... (button)

Figure 3–2 Display preferences

The screenshot shows the 'Display' preferences screen. On the left is a dark sidebar with icons for 'Preferences', 'General', 'Display', and 'Analysis'. The main content area is titled 'Display' and contains two sections:

- Colors:**
 - Color Scheme: Light (dropdown menu)
- Brightness:**
 - Screen Brightness: 80% (slider)

Power Management

When active, you can configure a sleep time of 1 to 30 minutes. By default, the sleep time is 15 minutes. **Power Management** turns off the display and the power LED goes from green to red.

Reddy goes into sleep mode when the touchscreen and keypad buttons (except the power button) are idle for the **Sleep Delay** period.

To exit the sleep mode, quickly press the power button, touch the display, or press any of the other keypad button.

Figure 3–3 Analysis preferences

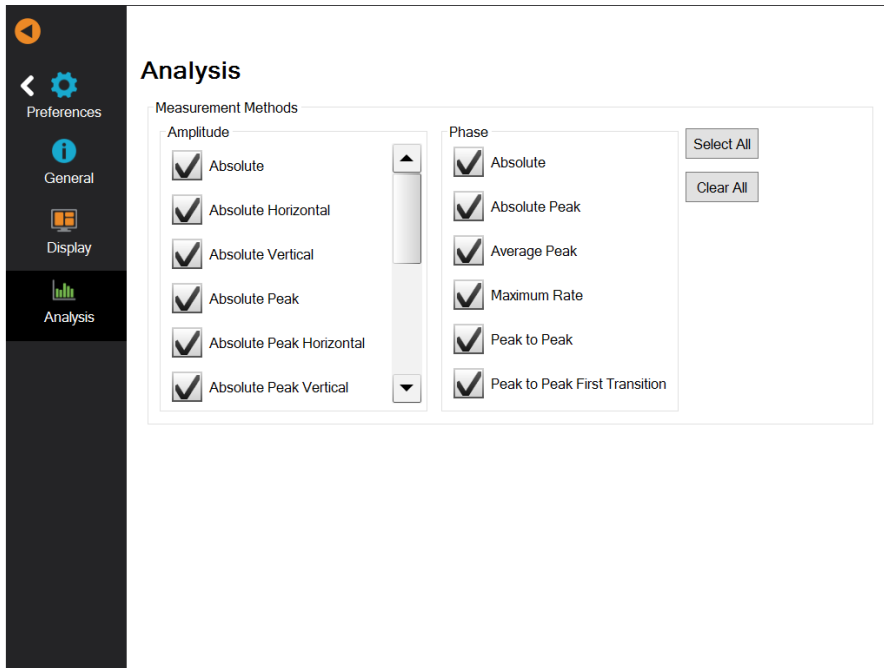

Figure 3–4 Help



Chapter 4

Keypad and Keyboard Functions

Keyboard Shortcut Keys

The following lists all the keyboard shortcuts for Reddy®. When you are using a physical keyboard with the instrument, you can achieve the same results as with the Reddy keypads by using those keyboards shortcuts.

Table 4–1 Keyboard shortcut keys

Keypad Function	Keyboard Shortcut
Left arrow	Left arrow key
Up arrow	Up arrow key
Right arrow	Right arrow key
Down arrow	Down arrow key
Start/Stop acquisition	F2
Keypad arrow mode selection	F3
Clear active Lissajous	F5
Probe nulling	F6
Change active view	ALT + F7
Maximize/Minimize view	ALT + F8
QUICK COPY	ALT + F9
Exit Magnifi GO	ALT + F10
Save inspection data	ALT + F11
Change layout	F11
Data display	F12
Enter	ENTER

Chapter 5

Using Reddy with Sharck Probes

Introduction

The medium Sharck™ probe used in this appendix contains two rows of 11 independent fingers. This array probe (SHARCK-W053-R-N05S) offers a coverage or active area of 53 mm (2.1 in). Other sizes of Sharck array probes are also available.

Figure 5-1 Medium Shark probe

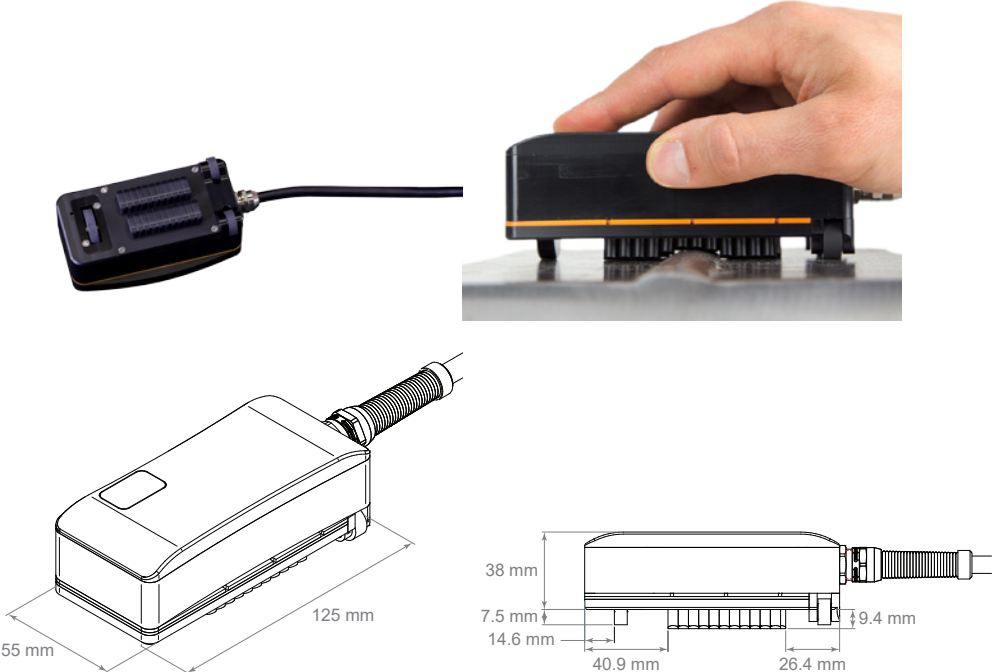

All the fingers of Sharck probes (patent pending) contain a three-coil assembly operating in a specific transmit-receive mode, called *tangential eddy current array* or TECA™. TECA was developed to detect and size the length and depth of axial surface-breaking linear indications in carbon steel. Sharck probes are also capable of detecting transverse cracks (perpendicular to the scan axis). The operating frequencies of the probes are 20 kHz and 80 kHz.

All Sharck probes are equipped with a high-resolution magnetic wheel encoder (20.53 points/mm). SHARCK-W053-R-N05S comes with a 12-pin encoder connector for Reddy and a standard 5 m cable. The encoder (and guiding wheels) are easily removable for cleaning and maintenance.

Figure 5-2 Removable Sharck encoder and guiding wheels

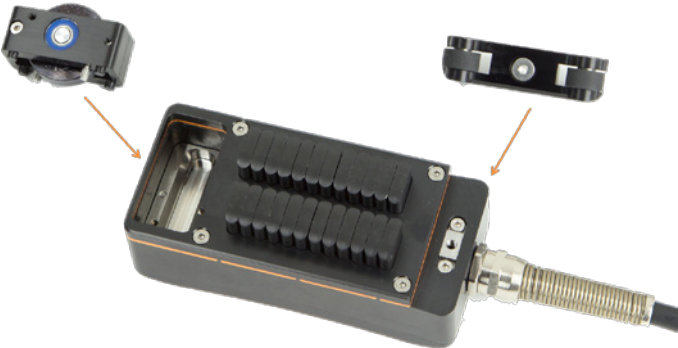

For details about Sharck probes (description, specifications, and typical performance), refer to the documentation supplied with your probes and the 4-page brochure.

Tangential Eddy Current Array Technology

TECA's coil arrangement and tangential operation mode allow obtaining a particular eddy current signal for surface-breaking cracks in carbon steel. As illustrated below, drivers induce eddy currents flowing mainly perpendicularly to the scan direction. When the eddy currents encounter longitudinal cracking, they tend to move around it by diving underneath or around the extremities.

Figure 5-3 Simplified TECA working principles

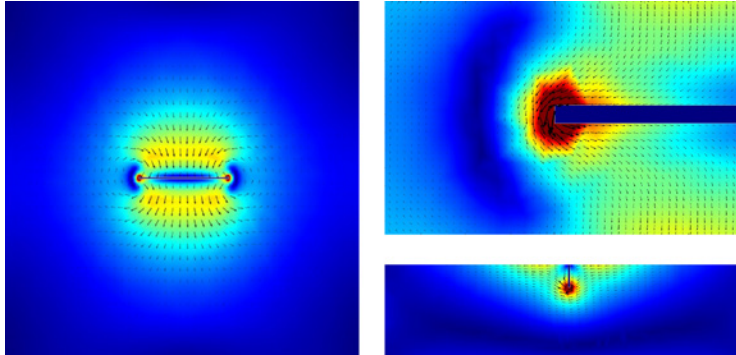

The main characteristics of TECA signals are:

- Almost flat liftoff signal
- Crack-like indications approximately 90° relative to the liftoff signal
- All crack-like indications feature the same phase shift
- Vertical signal amplitude linked to the defect depth (see figures below)

Figure 5-4 Typical signal signature

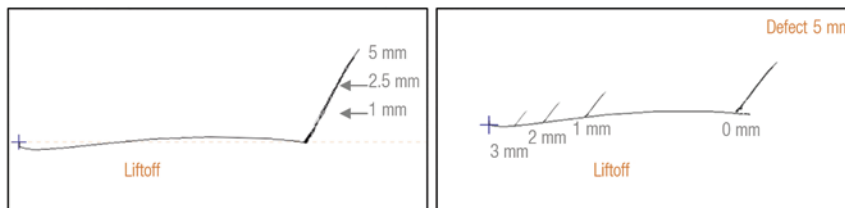

As the vertical signal amplitude is impacted by liftoff, the dynamic compensation process is designed to overcome any sizing and visualization issues. As illustrated above, any given defect's vertical signal component can be reduced by a factor of 2 or 3 (or more) when there is significant liftoff. However, because the coil design allows monitoring liftoff, it can be measured and the defect signal can be adjusted accordingly (see figure below).

Figure 5-5 Effects of compensation to liftoff on detected 5 mm deep defect with 0, 1, 2 mm liftoffs

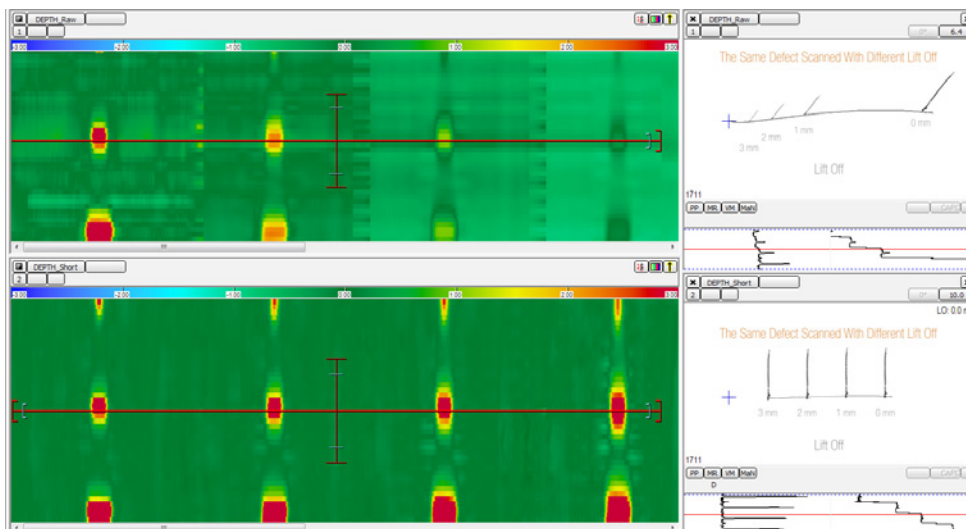

TECA relies on multiple depth curves calibrated at various liftoff values. The results are equivalent to 3D depth planes that enable correlating the crack depth to the vertical amplitude and the liftoff to the horizontal operating displacement, as illustrated on the left in the following figure. After compensating for liftoff, the depth plane is linearized to obtain a fixed amplitude for a given defect, independent of the measured liftoff (right portion of the following figure).

Figure 5-6 Integrated 3D depth plane to correlate crack depth, vertical amplitude, and liftoff

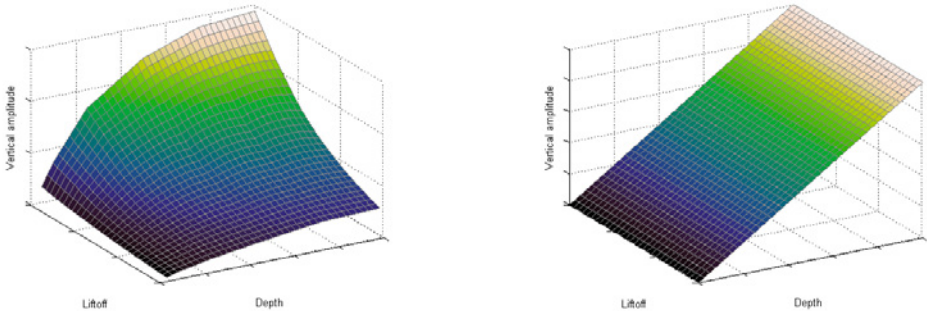

When the acquired data shows that the permeability varies from the normalization area, it is possible to readjust **User Mat** to compensate for the effect of the variation. Such variations can increase or decrease the vertical amplitude of a defect signal and therefore impact the depth sizing capabilities of the technique. The figure below illustrates an example of data before and after compensation. Although the detection is not affected, the sizing of a 5 mm deep defect is 7.5 mm before adjusting **User Mat** and becomes 5 mm after.

Figure 5-7 Example data before/after adjusting **User Mat**

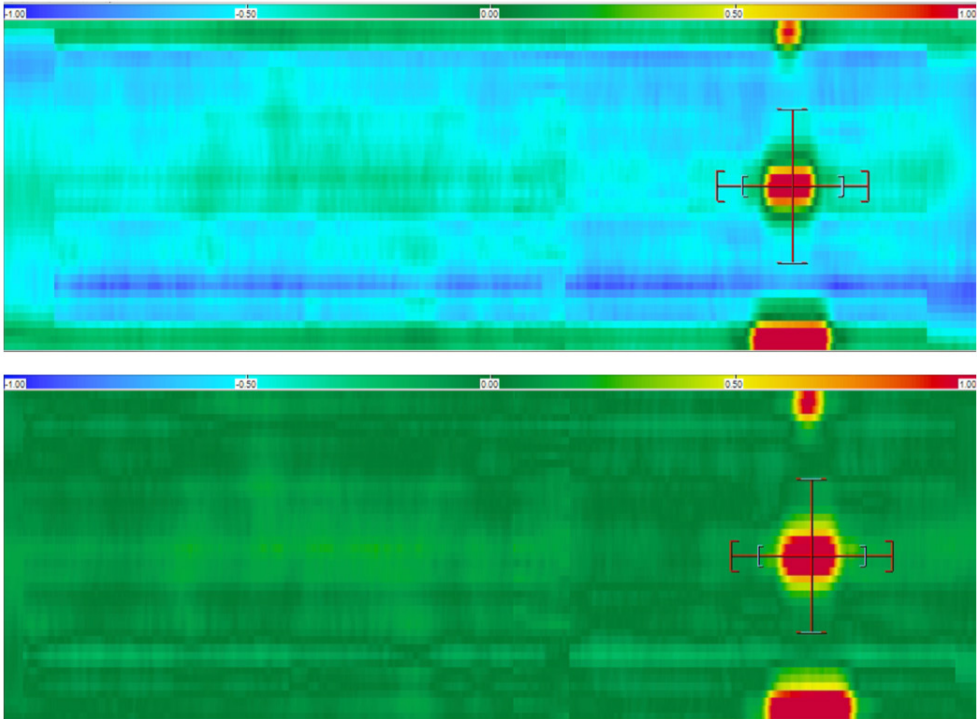

Getting Ready

1. Connect the Sharck probe's 160-pin ECA connector to the ECA connector on the right side of Reddy.
See chapter 1 for details about connector positions.
2. Connect the Sharck probe's encoder connector (12 pins) to the I/O connector on the right side of Reddy.
3. If it is not already on, press the power button on the front of Reddy to turn it on.

Notes

- You may connect and disconnect Sharck probes when the instrument is on.
- Reddy verifies the probe's compatibility to make sure that the current setup is valid.

4. In the backstage view, tap **Project**.
5. Create a new inspection folder or open an existing one by tapping **Create Inspection** or **Open Inspection**, respectively.

Figure 5–8 Backstage view: Create/Open inspection



Figure 5–9 Creating an inspection project

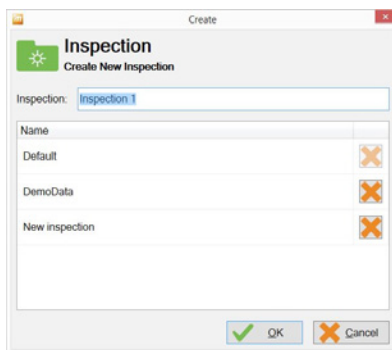

6. If you are creating a new inspection folder, type its name in the **Inspection** text box.
7. Tap **OK**.

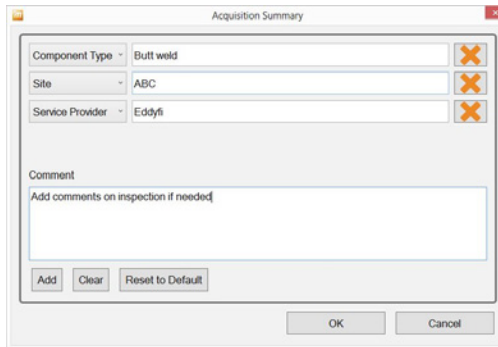
Figure 5–10 Acquisition Summary dialog box

The Acquisition Summary dialog box contains the following fields and controls:

- Component Type: Butt weld
- Site: ABC
- Service Provider: Eddyfi
- Comment: Add comments on inspection if needed
- Buttons: Add, Clear, Reset to Default, OK, Cancel

8. Create a new setup or open an existing setup by tapping **Create New Setup** or **Open Setup**, respectively.

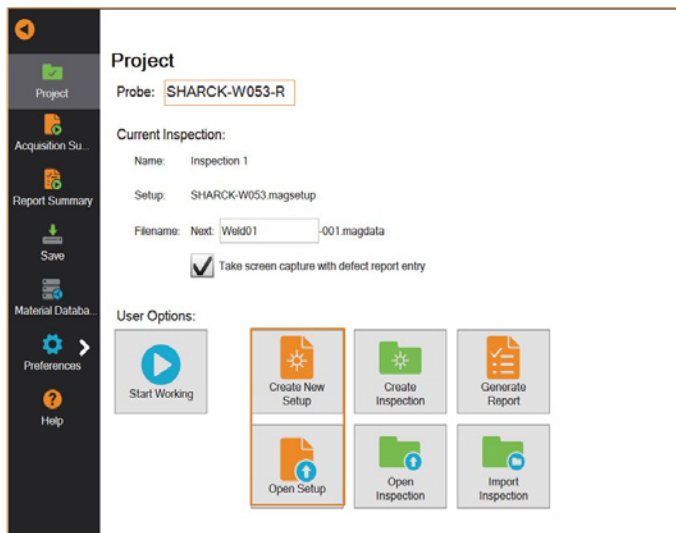
Figure 5–11 Backstage view: Create/Open setup

The Backstage view displays the following information and controls:

- Project:** SHARCK-W053-R
- Current Inspection:**
 - Name: Inspection 1
 - Setup: SHARCK-W053.magsetup
 - Filename: Next: Weld01 -001.magdata
 - Take screen capture with defect report entry
- User Options:**
 - Start Working
 - Create New Setup
 - Create Inspection
 - Generate Report
 - Open Setup
 - Open Inspection
 - Import Inspection

9. Once you are done, tap **Start Working**.
Magnifi GO switches to the front stage view.

Note

When you open a new inspection folder for the first time and then tap **Start Working**, the **Acquisition Summary** dialog box appears. The information you specify here is associated to this inspection folder. You can tap **Acquisition Summary** in the backstage view to open it again at a later time. When you are done, tap **OK**.

Setting Up Your Inspection

Opening an Existing Setup

1. In the backstage view, tap **Open Setup**.
2. In the **Open Setup** dialog box, on the **Master List**, select the appropriate setup file (in this case, SHARCK-W053).

All standard Reddy probe setups are available on this list.

Figure 5–12 Open Setup dialog box

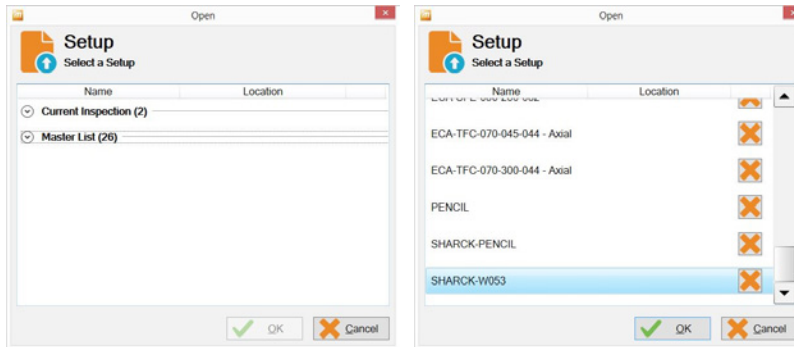

3. Tap **OK**.
4. Verify that the setup file is correctly applied.

Figure 5–13 Verifying the applied setup

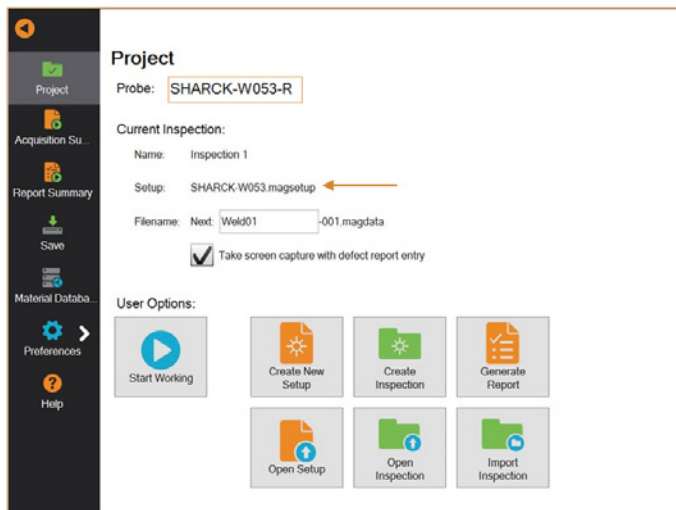

Creating a New Setup with the Setup Wizard

1. In the backstage view, tap **Create New Setup**.

The new setup wizard starts.

Note

Every step of the setup wizard has default values. You can modify them to suit your needs and applications.

2. In the **Component Definition** dialog box, select **Carbon steel weld**, and then adjust the parameters for the part(s) to be inspected, if desired.

Note

From this point on, all the default values of the wizard are designed to be appropriate for the Sharck probe.

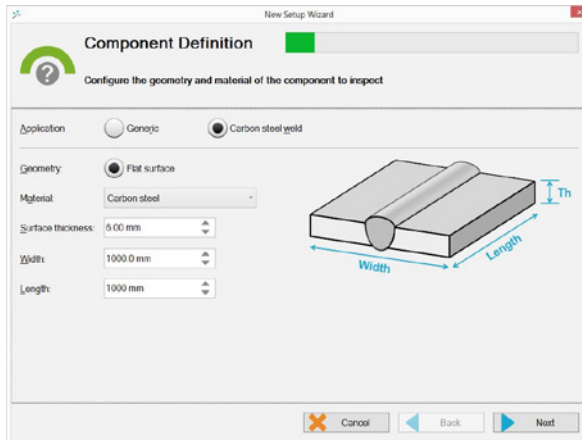
Figure 5–14 Component definition

3. Tap **Next**.

4. In **Probe Selection**, select the setup corresponding to the Sharck probe connected to Reddy.

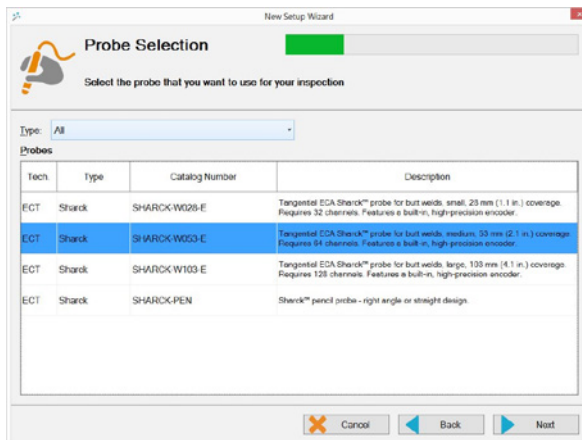
Figure 5–15 Probe selection

5. Tap **Next**.

6. In **Scan Definition**, select the encoder and specify the type of scan.

Note

Do not configure the maximum probe speed at a value higher than 200.0 mm/s (7.9 in/s). By default, the maximum density value is optimized at 4.0 samples/mm. We recommend that you avoid modifying it.

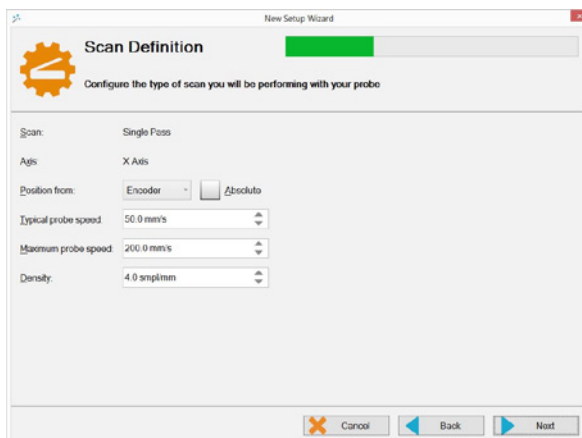
Figure 5–16 Scan definition: configure scan

7. Tap **Next**.
8. Configure the encoder and the starting position.

Note

Apart from the **Preset** value, you should not modify any of the encoder parameters because they are already optimum for the Sharck probe.

Figure 5–17 Scan definition: configure encoder and start position

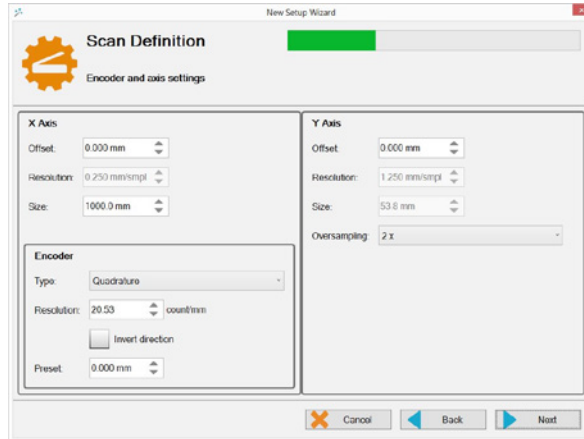

9. Tap **Next**.
10. In **Data Definition**, adjust the properties of your filters.

Figure 5–18 Data definition: configuring filters

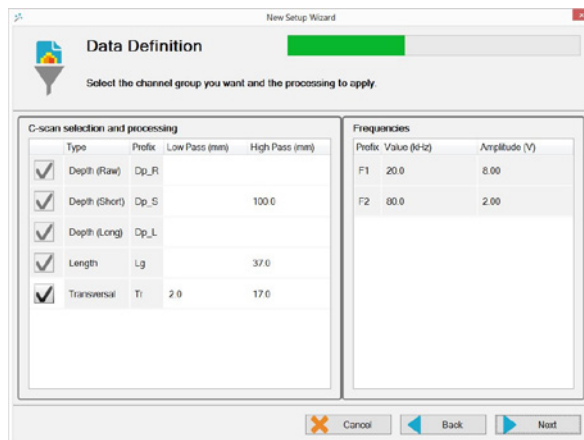

Notes

- Sharck probe setups are tailored for carbon steel. That is why you cannot change the frequencies and injection voltages of these setups. Moreover, as most channel groups are necessary for analysis, you can only disable the transverse group.
- We strongly recommended that you do not modify the median filter value, as it is configured to detect and size 25 mm long defects in C-scan short.

11. Tap **Next**.
12. In **Indication Codes**, create the indication code list you wish to use during your analysis.

Figure 5–19 Indication codes

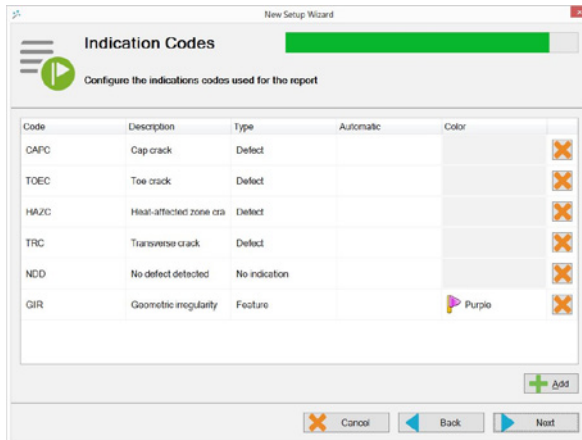

13. Tap **Next**.

14. In **Display**, configure your display properties.

Figure 5–20 Display properties

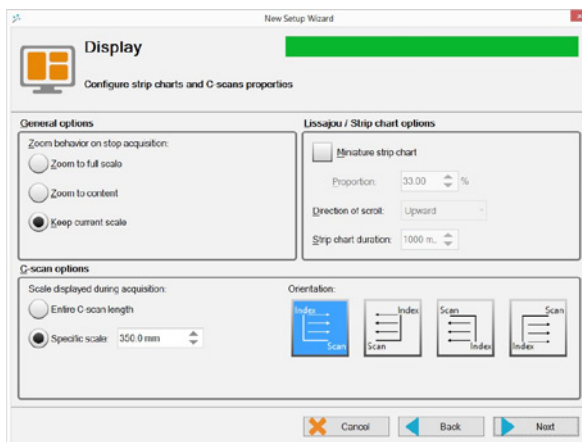

15. Tap **Next**.

16. In **Display**, configure the layout of your display.

Figure 5–21 Display layout

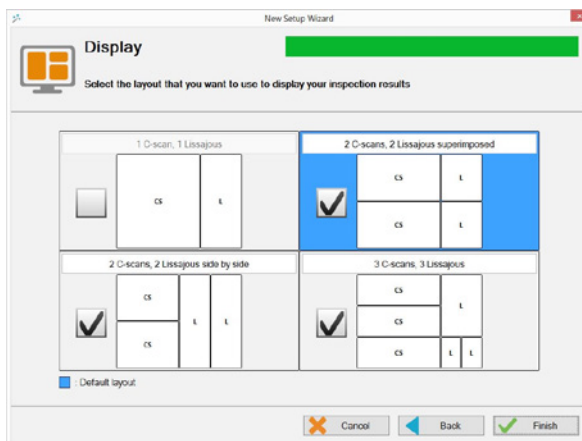

Note

The layout highlighted in blue is the layout displayed when you start working. To select any of the other layouts selected in the wizard, press the **Change layout** button (see page 3) on Reddy's keypad or in the front stage view, tap **Layout**, and then **Selecting Layout**.

Nulling the Sharck Probe

1. Position the Sharck probe on the plastic portion of the normalization plate.

Note

The normalization plate should be on a steady, flat surface and shall be at least 10 cm (4 in) from any ferritic surfaces.

2. Apply even pressure on the probe.

Figure 5–22 Nulling the Sharck probe



Note

To balance the probe, we strongly recommend that you press the probe onto a non-metallic surface, instead of keeping it in the air. This avoids having one or only a few fingers compressed at a lower position than neighboring fingers, which can slightly affect the probe's balance.

3. On Reddy's keypad, press the Probe nulling button (see page 3).

Alternatively, in the front stage view, on the **Home** or **Calibration** ribbon, tap **Null**.

Calibrating the Sharck Probe

1. In the front stage view, on the **Calibration** ribbon, tap **Assisted Sharck**.

Figure 5–23 Sharck Assisted Calibration

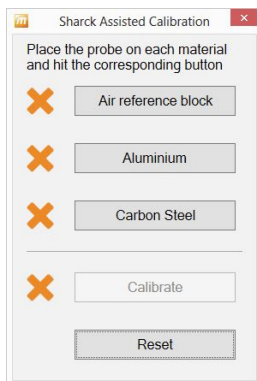

2. Position the Sharck probe on the plastic portion of the normalization plate (REFPL-CAL-SHARCK-AAL-LG).

Note

The normalization plate should be on a steady, flat surface and shall be at least 10 cm (4 in) from any ferritic surface.

3. Apply even pressure on the probe.

4. In the **Sharck Assisted Calibration** dialog box, tap **Air reference block**.

When the necessary data is acquired, a green check mark appears next to **Air reference block**.

5. Position the Sharck probe on the aluminum portion of the normalization plate.

6. Apply even pressure on the probe.

7. In the **Sharck Assisted Calibration** dialog box, tap **Aluminum**.
When the necessary data is acquired, a green check mark appears next to **Aluminum**.
8. Position the Sharck probe on the carbon steel component to be tested.
9. Apply even pressure on the probe.
10. In the **Sharck Assisted Calibration** dialog box, tap **Carbon steel**.
11. Move the probe over a distance of 200 mm (7.9 in) on the component to be tested (over the weld).
You have approximately 4 seconds to carry out the scan from the moment you tap the **Carbon steel** button. When the necessary data is acquired, a green check mark appears next to **Carbon steel**.

Note

If non-magnetic paint or coating is present, there is no need to remove it (unless it is thicker than 3 mm (0.118 in)). The Sharck calibration process takes this liftoff into account and manages accordingly.

12. In the **Sharck Assisted Calibration** dialog box, tap **Calibrate**.
When the necessary data is acquired, a green check mark appears next to Calibrate.

Figure 5–24 Sharck Assisted Calibration: Calibration complete

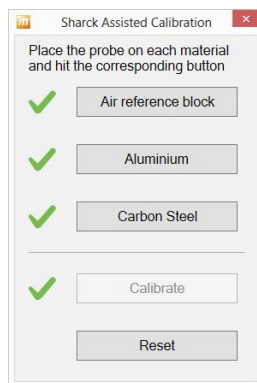

Note

If, for any reason, you must normalize the probe again, tap **Reset** before you perform the above procedure.

13. To close the dialog box, tap the red X in its upper-right corner.

Collecting Data

1. Position the Sharck probe on the plastic portion of the normalization plate (REFPL-CAL-SHARCK-AAL-LG).

Note

The normalization plate should be on a steady, flat surface and shall be at least 10 cm (4 in) from any ferritic surface.

2. Apply even pressure on the probe.
3. On Reddy's keypad, press the Probe nulling button (see page 3).
Alternatively, in the front stage view, on the **Home** or **Calibration** ribbon, tap **Null**.
4. Position the probe on the part to be inspected across the weld, as illustrated.
We recommend that the center coverage reference mark be on the centerline of the weld.

Figure 5–25 Sharck probe on carbon steel weld

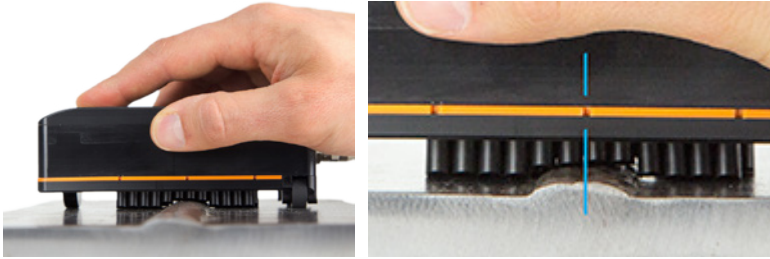

5. On Reddy's keypad, press the Start/Stop acquisition button (see page 3).
Alternatively, in the front stage view, on the **Home** or **Calibration** ribbon, tap **Acquire**.

Note

To ensure that the entire weld cap is covered by the probe's fingers, whenever possible, position the center of the probe's active area on the centerline of the weld. Depending on the width of the weld crown and the welding process, the probe may also cover all or part of the heat-affected zone (HAZ).

6. Placing appropriate pressure on the probe, move it longitudinally along the weld.

Note

The maximum speed is 200mm/s (6 in/s) for the small (W028) and medium (W053) Sharck probes.

7. When scanning is complete, on Reddy's keypad, press the Start/Stop acquisition button (see page 3).
Alternatively, in the front stage view, on the **Home** or **Calibration** ribbon, tap **Stop**.

Notes

- To maintain data files at a reasonable size and facilitate analysis, when inspecting very long welds, we recommend that you divide your inspection into several appropriately short acquisitions (e.g. less than 3m (10ft)).
- Balance the probe regularly between scans on the plastic portion of Eddyfi's normalization plate (REFPL-CAL-SHARCK-AAL-LG) to avoid any signal drift.
- Data is positioned according to the origin (0,0) illustrated below. This is the top view of the probe (transparency). Along the scanning axis, the origin is 38.75 mm (1.53 in) from the front of the probe's casing (the front being the edge of the casing closest to the scan direction).

Figure 5–26 Probe origin and defect positioning along the scanning axis (probe shown top view)

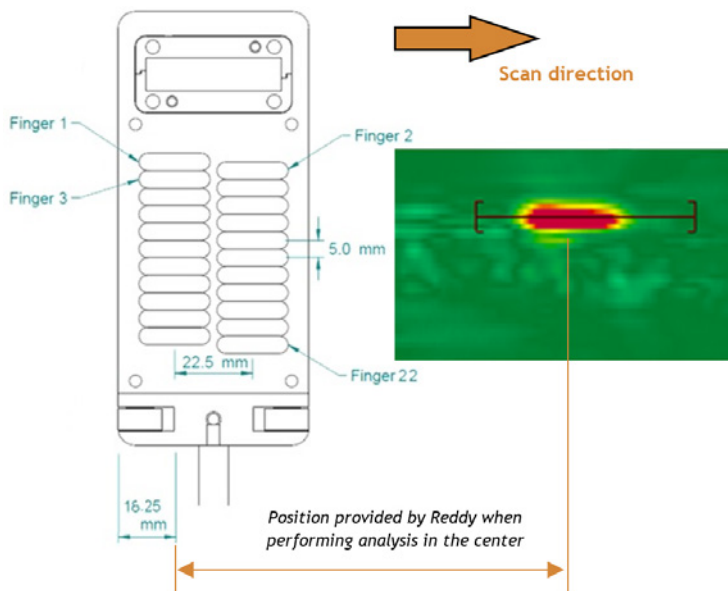

- Data simultaneously appears on the Reddy display during acquisition and some of the functions of the **Home** and **Calibration** ribbons are disabled.

Figure 5–27 Disabled functions during acquisition

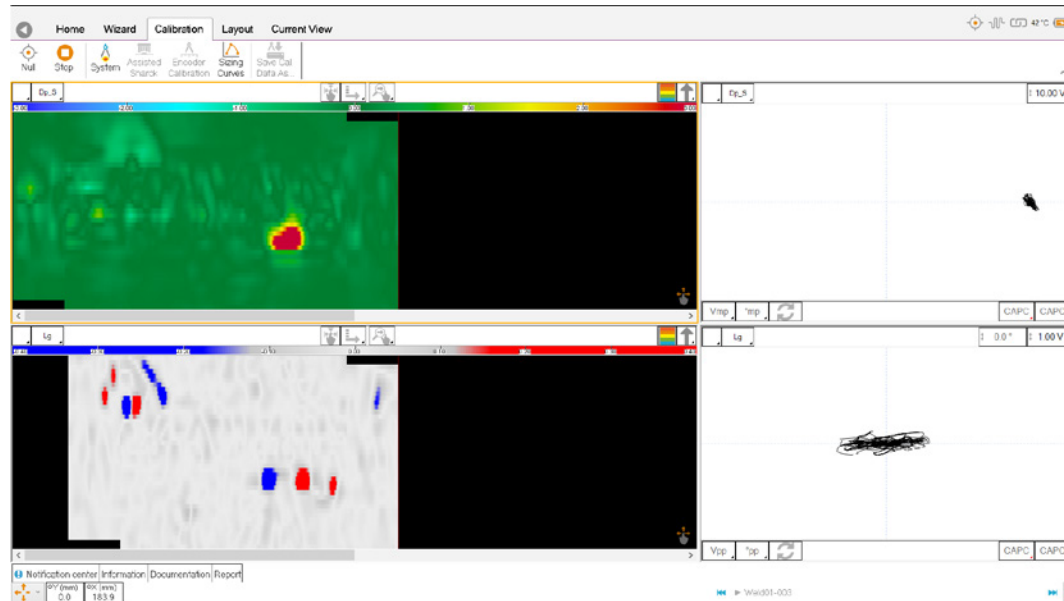

- When you stop the acquisition, you can save the data directly on **Home** ribbon by tapping **Save Data**. See the following section for details.

Saving Data

Once your acquisition is over and stopped, save your data as follows.

- In the front stage view, on the **Home** ribbon, tap **Save Data**.
Alternatively, on the Reddy keypad, press the Save inspection data button (see page 3).

Figure 5–28 Saving data

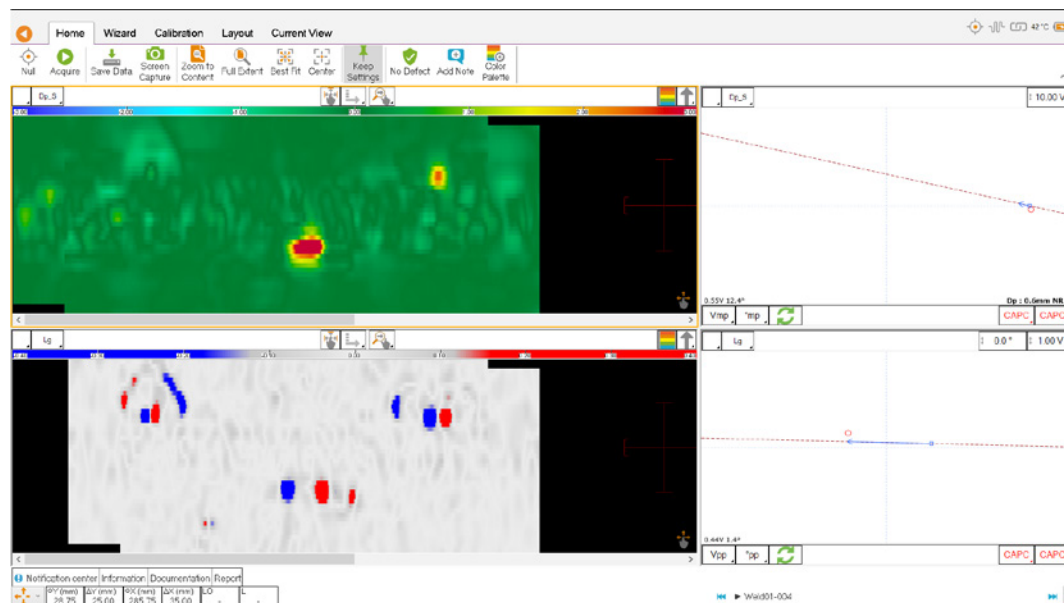

Notes

- When data is saved, **Save Data** is disabled (grayed) and a new entry appears in the file navigator.
- An orange icon appears before the filename to show that the data is saved, but has not been analyzed yet. The icon turns green when you have analyzed the data. See *Saving Data* for details.
- A camera icon appears next to the file name of a screen capture.

Analyzing Data

Available C-Scans

There are five available C-scans in the Sharck probe setups:

- Depth Raw C-Scan (raw data without processing, showing depth view — axial)
- Depth Short C-Scan (depth view — axial, compensated and filtered)
- Depth Long C-Scan (depth view — axial, compensated)
- Length C-Scan (length view — axial, filtered)
- Transverse C-Scan (depth view — transverse, filtered)

The same channels are used in the Depth Short and Depth Long C-scans, but different processes are applied to them. A median filter is applied to the Depth Short C-scan to reduce the noise induced by the state of the surface under test or by the weld. The main drawback of this filter is that it tends to “cut” long defects. This is why we recommend using the Depth Long C-scan to assess flaws longer than 25 mm (1 in).

We also strongly recommend that you visualize the Depth Raw C-scan first to determine whether to use the Depth Long or Depth Short C-scan to assess flaws, thus avoiding missing defects. This C-scan also helps position the weld on the scan and assess the presence of permeability variations.

Analysis Methodology

Data is analyzed by reviewing the Depth Short or Depth Long and the Length C-scans. Flaw-like indications are characterized by the presence of bright spots on the Depth C-scans and two aligned spots (opposed colors in the palette) in the Length C-scan (representing a differential signal visualized on the impedance plane) at the same location, aligned on both axes of the cursor.

Figure 5–29 Flaw-like and spurious indications

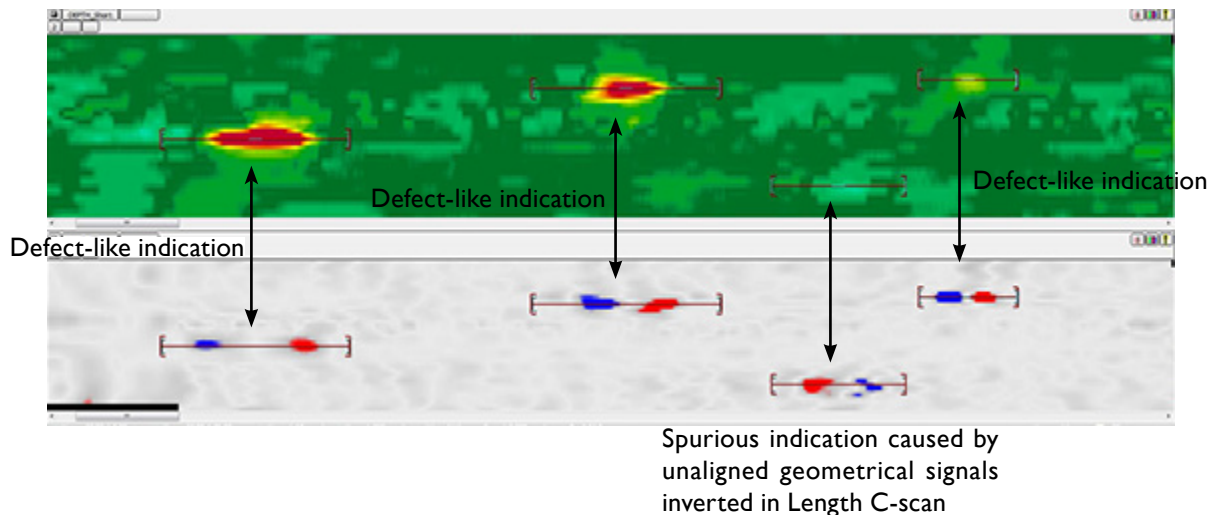

When flaw-like indications are detected, you must isolate them with the cursor to obtain the sizing information (depth, length, liftoff, and position). Place your cursor over an indication and maximize the signal in the impedance plane view of the Depth C-scan you are using, while making sure that you keep both extremities of the defect within the cursor in the Length C-scan.

In the Length C-scan, resize your cursor horizontally so that it contains the entire indication (the aperture of the cursor should be equal to the measured length plus 15 mm (0.59 in), which corresponds to the each of the probe’s elements). All measurements are made automatically and appear on the Reddy display.

Figure 5–30 Sizing information

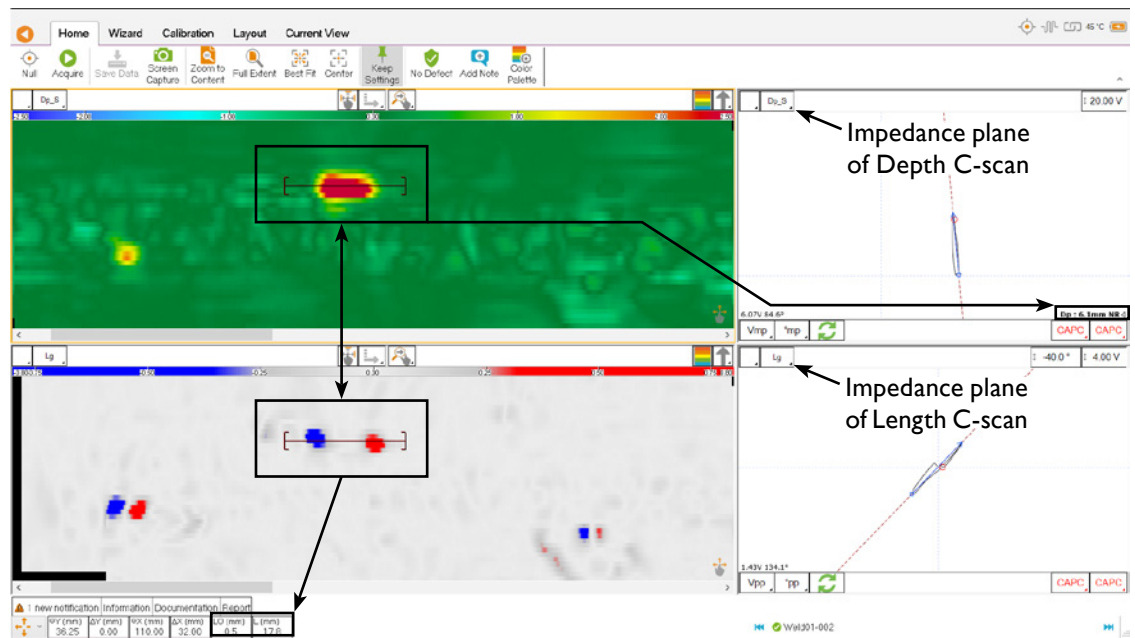

Analyzing Data with Reddy

Before analyzing data, if you want to include screen captures in your report, make sure that the check box below is selected in the **Project** section of the backstage view. If you do not, reports only include summaries of your findings.

Figure 5–31 Take screen captures with defect report entry check box

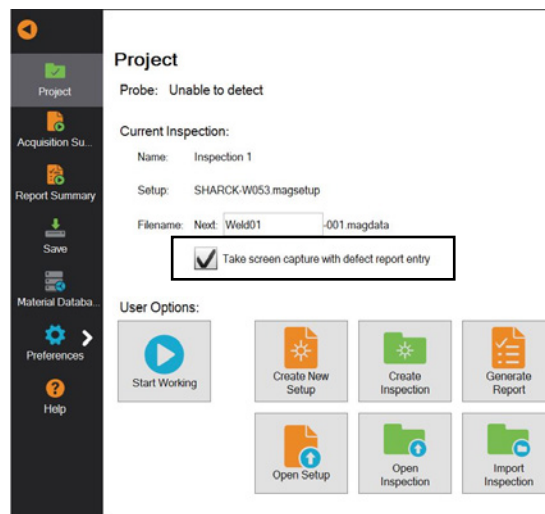

To analyze data with Reddy, proceed as follows:

1. Find the file navigator at the bottom of the Magnifi GO front-stage view.
2. Tap the file that you want to open.
3. On the **Layout** ribbon, tap **Select Layout**, and then tap the layout that you want to use.

Figure 5–32 Selecting a layout



4. Review your data and move your cursor to an area of interest.

5. Resize the cursor in such a way that the flaw-like indication in the Length C-scan is completely inside the cursor.
The width of your cursor should be equal to the defect's measured length plus 15 mm (0.59 in).
6. To enter the detected defect as an entry in your report, select the adequate indication code, and then tap it in an impedance plane.
The entry is grayed to show that it is now part of the summary report.

Figure 5–33 Entering a detected defect

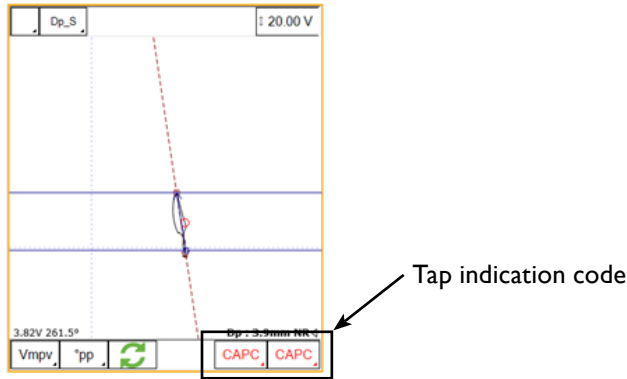

Notes

- The current sizing method appears at the bottom of impedance planes. Tap it to switch methods in each view. For appropriate measurements, use the Average Peak Vertical (Vmpv).

Figure 5–34 Measurement methods

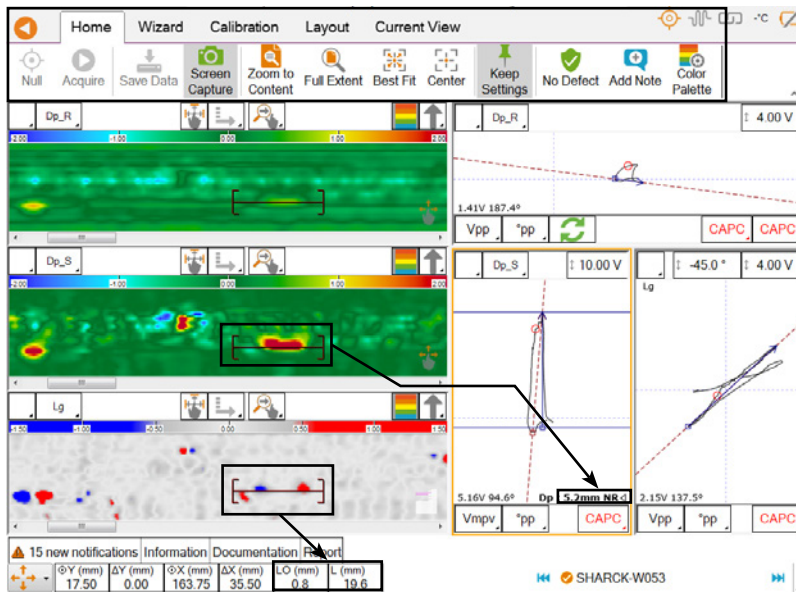

- To quickly view your report entries, tap the **Report** tab at the bottom of the Magnifi GO front stage view.

Figure 5–35 Report tab

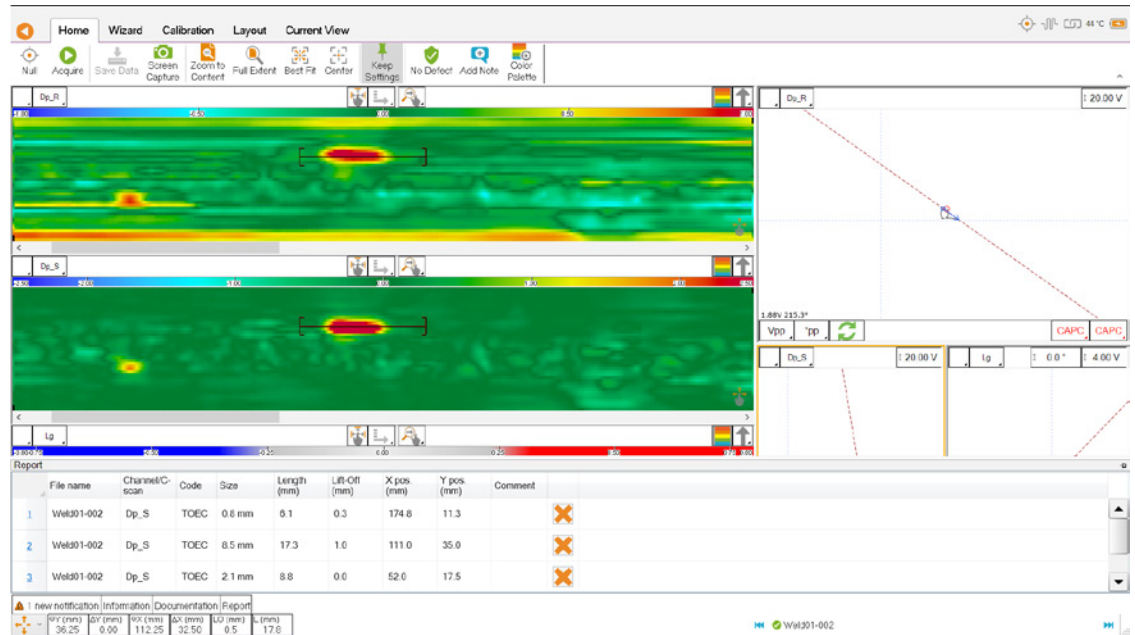

- An axial crack-like indication is typically set to a phase of approximately 90° in the Short and Long impedance places, and 135° phase in the Raw impedance plane.
- A transverse crack-like indication is typically set to a phase approximately 45° in the Transverse impedance plane. Generally, the length signals of such defects have a color opposite that of axial cracks (red-blue instead of blue-red, see Figure 41).
- Those values can be altered by geometrical features and/or permeability variations.
- A differential signal appearing in the Length impedance plane with a mostly horizontal phase (generally no bright spot in the Depth C-scans) can typically be considered a geometrical effect from the weld, such as excess metal, undercut, etc.
- Size defects shorter than 25 mm (1 in) with the Depth Short C-scan. Size defects longer than 25 mm (1 in) with the Depth Long C-scan.

Figure 5–36 Transverse C-scan



Saving and Reporting

1. In the backstage view, tap **Report Summary**.
2. Complete the necessary information.
Add or remove information as necessary.

Figure 5–37 Report summary

Field	Value
Client	AEC
Component Type	Weld
Component SN	12345
Service Provider	Eddyfi
Work Order	1
Procedure	Sharck inspection
Calibration Standard	REFFL-CAL-SHARCK-AAL-LQ
Inspector	Mr Smith

Comment

Add Clear Reset to Default

3. To save the setup and inspection data in the current inspection project, on the left menu bar, tap **Save**.
4. On the left menu bar, tap **Project**.
5. To edit your report, tap **Generate Report**.
The **Section Selection** dialog box appears.
6. Select the elements that you want to see appear in your report.

Figure 5–38 Report options

Section Selection
Sections to Include in Report

Report Summary

Date and Signature

Screen Captures

Cancel Next

7. Tap **Next**.

8. In **Report Summary**, confirm the information and edit it as necessary.

Figure 5–39 Report summary

Generate Report

Report Summary

Configure the Summary Section

Client: ABC

Component Type: Weld

Component S/N: 12345

Service Provider: Eddyfi

Work Order: 1

Procedure: Sharck inspection

Calibration Standard: REFPL-CAL-SHARCK-AAL-LG

Inspector: Mr Smith

Comment

Add Clear Reset to Default

Cancel Back Finish

9. When you are done, tap **Finish**.

The report is generated. Use the controls at the top of the report viewer to save it to various formats, navigate the report, etc.

Figure 5–40 Inspection report

Analysis Report

eddyfi®

Report Summary

Component Type	Weld	Client	ABC
Inspector	Mr Smith	Service Provider	Eddyfi
Component S/N	12345	Work Order	1
Procedure	Sharck inspection		

Defect Table

#	File Name	Channel C-scan	Code	Size	Length (mm)	Lift-off (mm)	X pos (mm)	Y pos (mm)	Comment
1	Weld01-003	Dp_S	TOEC	7.8 mm	0	0	0.1	0	
2	Weld01-003	Dp_S	TOEC	2.5 mm	0	0	0.2	0	
3	Weld01-003	Dp_S	TOEC	0.9 mm	0	0	0.1	0	

Signature: _____ Date: _____

Chapter 6

Maintenance and Troubleshooting

Maintaining Reddy®

Because of its design, Reddy only requires minimal maintenance. Since Reddy has no moving parts, it also does not require any preventive maintenance on your part. We recommend a regular inspection of the instrument to ensure that it is properly grounded. We also strongly recommends an annual calibration and a factory-performed preventive maintenance by an officially qualified Eddyfi technician.

Cleaning Reddy

1. Make sure that the instrument is off and that the power cord is disconnected.
2. To bring the instrument back to its original finish, clean it with a soft cloth.



Warning

Do not spray the instrument with chemical cleansers or water. Doing so may lead to short circuits and damage to the instrument.

Important

To remove stubborn stains, use a cloth moistened with soft, soapy solution. Do not use abrasives or strong solvents as they could damage the finish. Wait until the instrument is completely dry before connecting the power cord or cables.

Updating and Upgrading Magnifi® GO

Before you can perform any maintenance on Magnifi GO, you must first meet the following requirements:

- USB mass storage device with a minimum of 4 GB free space ×1
- Hardwired Internet connection

There are two methods of updating or upgrading Magnifi GO.

Standard Method

1. Connect Reddy to a power outlet with the power cable.
2. Turn on Reddy and wait for Magnifi GO to start.
3. Download the *.ReddyOS file from the Eddyfi Web site.
Save the file in an easy-to-remember location on your computer.
4. Copy the *.ReddyOS to the root of a USB mass storage device.
5. Once copied, remove the mass storage device and connect it to one of Reddy's two USB ports
A dialog box appears prompting you to proceed.

Important

Do not connect your mass storage device to the QUICK COPY USB port.

6. Tap **Yes**.
7. In the list that appears, tap **OS Update**, and then tap **Update**.
The instrument restarts. A window opens prompting you to confirm whether you want to update the system.
8. To select **Yes**, press the keypad's up arrow (see page 3). Press any other button to select **No**.
You are prompted to confirm again.
9. Press the keypad's up arrow again.
The update process starts. This normally takes between 5 and 10 minute, depending on the speed of your mass storage device. When the process is complete, the system restarts.
10. Activate Windows.
See Activating Windows on page 50 for details.

System Recovery Method

1. Connect Reddy to a power outlet with the power cable.
2. Make sure that Reddy is off.
If it is not, turn it off.
3. Turn on the instrument.
4. Immediately and simultaneously press the probe nulling button and the change layout button (see page 4) until the following appears.

Figure 6–1 Options menu

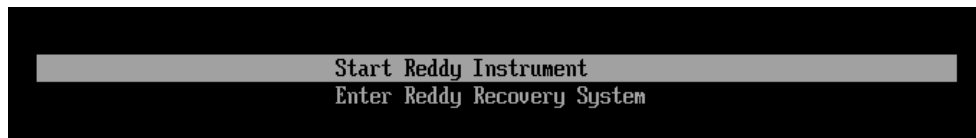

5. With the keypad arrows, select **Enter Reddy System Recovery**, and then press the Enter button (see page 4).
You are prompted to wait until the following appears.

Figure 6–2 System recovery interface

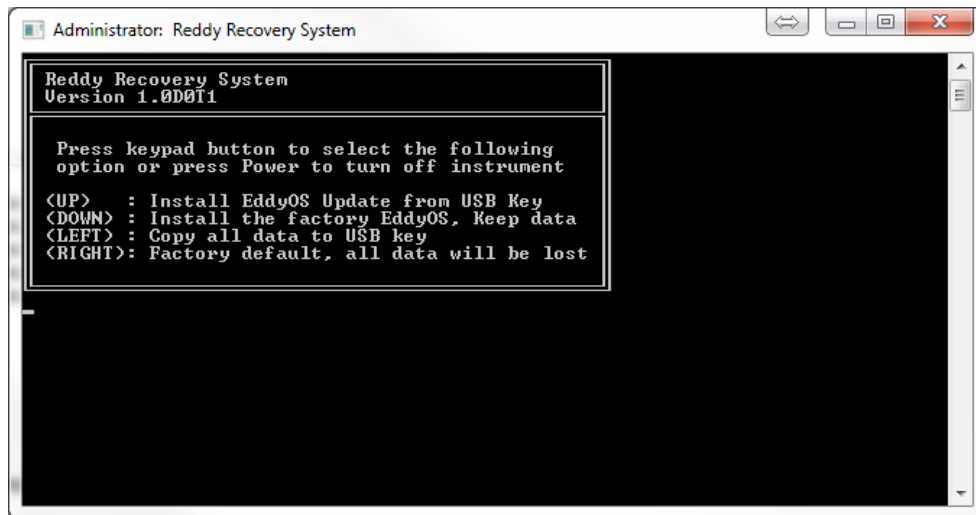

6. Using the keypad arrows, select **Install the factory EddyOS update, keep data**.
7. When prompted, press the up arrow of the keypad.
The update process starts. This normally takes between 5 and 10 minute. When the process is complete, the system restarts.
8. Activate Windows.
See [Activating Windows](#) on page 50 for details.

Activating Windows

Microsoft requires that you activate Windows to be able to use it. The activation process is automatic when you connect Reddy to the Internet through an Ethernet cable. To proceed :

1. Make sure that Reddy is on and that MagnifiGO is running.
2. Connect an Ethernet cable to Reddy.
3. Connect the other end of your Ethernet cable to a network (local area network or other access point).

Wait until a dialog box confirming the activation of Windows appears on screen. If you do not activate Windows, every time you start Reddy, a message will remind you to do so. You have 30 days to activate Windows before it locks up.

Known Issue With System Updates/Upgrades

On some units, a blue Windows error screen may appear when you attempt to enter the system recovery, which can cause the unit to start normally. Try performing the update procedure again.

Troubleshooting

To troubleshoot Reddy, connect it to a workstation running Magnifi. Refer to the Magnifi documentation for details.

Troubleshooting System Updates/Upgrades

- No update file found. This appears in the update list or in the system recovery. Make sure that you only have one USB mass storage device connected to Reddy. Also make sure that the file is in the root folder of the device.
- Cannot display the options screen. You do not press and hold the probe nulling button and the change layout button (see page 4) long enough, you do not press and hold the correct buttons, or you do not press and hold the buttons quickly enough after turning on Reddy. Try holding the power button for two seconds, and then quickly pressing and holding the probe nulling button and the change layout button.
- Using the system recovery method, Reddy restarted normally or a blue error screen appeared on the screen. Perform the procedure again.
- Unable to activate Windows. Make sure that your Ethernet cable is sound. Make sure that you have Internet access. Make sure you are using DHCP. Turn on Reddy after connecting the Ethernet cable and network. If you do not see a message warning you that Windows is not activated when it starts, Windows is activated.

Chapter 7

Specifications

General

Table 7-1 General specifications

Specification		Value
Dimensions (W×H×D)		355×288×127 mm (14.0×11.3×5.0 in)
Weight	With batteries	6.6 kg (14.5 lb)
	Without batteries	5.7 kg (12.5 lb)
Volume		13 L (791 in ³)
Power requirements		100–240 VAC ±10% 50–60 Hz
Power supply		Direct VAC (100W) or onboard batteries
Maximum input frequency		1.5A
Batteries	Type	Li204SX-7800 rechargeable lithium-ion, DOT compliant
	Typical life	6–8 hours (with both batteries in instrument)
System warm-up time		15 minutes This is the time necessary for Reddy® to reach its optimal accuracy after being turned on. We recommend that you wait 15 minutes before balancing probes or performing acquisitions.
Display		26.4 cm (10.4 in) Non-reflective (AR coating) Anti-fingerprint (oleophobic coating) 3 mm (1/8 in), chemically strengthened glass cover Optically bonded LCD and touchscreen Passive backlight enhancement
Video output		HDMI
Storage		SSD, 100 GB
Cooling		Sealed and fanless
Encoders		2 axes, quadrature
Connectivity		Gigabit Ethernet, Wi-Fi, Bluetooth, USB 2.0 (×3)
Probe recognition and setup		Automatic Reddy uses an ID device in Eddyfi probes that contains information to set up acquisitions and confirm compatibility between the setup and the probe.

Environmental

Table 7-2 Environmental specifications

Specification	Value
IP rating	Designed for IP65
Operating temperature	0–40 °C (32–104 °F)
Operating humidity	95%, non-condensing
Storage temperature	–20–60 °C (–4–140 °F)
Storage humidity	95%, non-condensing
Pollution degree rating	2
Compliance	ASME, EN 61010-1, CE, WEEE, FCC Part 15B, ICES-003, AS/NZS CISPR 22, RoHS

ECA

Table 7-3 Eddy current array specifications

Specification		Value
Channels	Reddy 32	32
	Reddy 64	64
	Reddy 128	128
Frequency range		5 Hz–10 MHz
Frequencies		2 simultaneous
ECA connector		160-pin array
Multiplexer		SmartMUX™: integrated, universal, and programmable

ECT

Table 7-4 Eddy current testing specifications

Specification	Value
Inputs	4
Frequency range	5 Hz–10 MHz
Frequencies	4
ECA connector	19-pin Fischer
Generator output/Coil drive	Up to 20Vpp
Injection modes	Multiplexed, simultaneous, continuous
Receiver gain	41 dB range 23–64 dB
Data resolution	16 bits
Acquisition/Sampling rate	Up to 50 000 samples/s

Appendix A

Connector Reference

ECA Connector (160 pins)

The 160-pin connector available on the right side of the instrument, marked ECA, is specifically designed by Eddyfi. For details about this connector, contact Eddyfi directly at info@eddyfi.com.

ECT Connector (19 pins)

The ECT connector is used to hook up eddy current testing probes. The signals from the connector are the eddy current generator outputs, the eddy current channel amplifier inputs, the multiplexing outputs, and a DC power supply.

Table A-1 ECT connector data

Type	19-pin, female
Manufacturer P/N	Fischer DBPU 1031 A019-130
Eddyfi P/N	MACN4091
Suggested cable connector	Fischer DBPU 1031 A019-142+ Eddyfi MACN0239

Table A-2 ECT connector pinout

Pin	Signal	Description
1	IWIRE_PROBE_ET_2 Probe	Probe identification
2	GEN1_50_100	ECT1 eddy current generator output 1 50 Ω or 100 Ω
3	HSWAP_ET_IN_2	Automatic probe detection
4	GND	Ground
5	GND	Ground
6	GND	Ground
7	GEN2_50_100	ECT2 eddy current generator output 2 50 Ω or 100 Ω
8	GEN1_OUT_2	ECT1 eddy current generator
9	GEN2_OUT_PSUP_2	ECT2 eddy current generator
10	OUT	Reserved
11	IN1_P	IN1 + input
12	IN1_N	IN1 – input
13	IN2_P	IN2 + input
14	IN2_N	IN2 – input
15	IN3_P	IN3 + input
16	IN3_N	IN3 – input
17	IN4_P	IN4 + input
18	IN4_N	IN4 – input
19	OUT	Reserved

I/O Connector (12 pins)

The I/O connector allows the instrument to send and receive various signals such as the acquisition start and stop commands, the encoder and rotation synchronization signals, the relay outputs, etc.

Table A-3 I/O connector data

Type	12-pin, female
Manufacturer P/N	Fischer DBPU 1031 A012-130
Eddyfi P/N	MACN4090
Suggested cable connector	Fischer S 1031 A012-142+ Eddyfi MACN0238

Table A-4 I/O connector pinout

Pin	Signal	Description
1	+5VEXT_2	+5V supply output
2	ENC1_PHA	Encoder phase A axis 1
3	ENC1_PHB	Encoder phase B axis 1
4	ENC2_PHA	Encoder phase A axis 2
5	ENC2_PHB	Encoder phase B axis 2
6	IN	Reserved
7	IN	Reserved
8	IN	Reserved
9	IN	Reserved
10	GND	Ground
11	OUT	Reserved
12	OUT	Reserved

Ethernet Connector

The Ethernet connector is used to connect the Reddy to a network through an Ethernet link. Eddyfi supplies a high-quality, military-grade Ethernet connector and cable. International Ethernet standards are used.

Table A-5 Ethernet connector data

Type	RJ45, female
Manufacturer P/N	PEI Genesis, Amphenol RJF22B00SCC
Eddyfi P/N	MACN4016

Table A-6 Ethernet connector pinout

Pin	I/O	Signal	Description
1	Bidirectional	Bi_DA+	Bidirectional pair A+
2	Bidirectional	Bi_DA-	Bidirectional pair A-
3	Bidirectional	Bi_DB+	Bidirectional pair B+
4	Bidirectional	Bi_DC+	Bidirectional pair C+
5	Bidirectional	Bi_DC-	Bidirectional pair C-
6	Bidirectional	Bi_DB-	Bidirectional pair B-
7	Bidirectional	Bi_DD+	Bidirectional pair D+
8	Bidirectional	Bi_DD-	Bidirectional pair D-

Important

Reddy® must be linked to a workstation with a category 5e, shielded, Ethernet cable or better of a maximum length of 100m (328ft).

HDMI Connector

The HDMI connector is used to output video from Reddy to an external display. International HDMI standards are applied.

Table A-7 HDMI connector data

Type	HDMI, female
Manufacturer P/N	Tyco Electronics 2007435-1
Eddyfi P/N	MACN4039

Table A–8 HDMI connector pinout

Pin	Signal	Description
1	TMDS Data2+	Transition minimized differential signaling (TMDS) positive data 2
2	TMDS Data2 Shield	TMDS data 2 shield
3	TMDS Data2–	TMDS negative data 2
4	TMDS Data1+	TMDS positive data 1
5	TMDS Data1 Shield	TMDS data 1 shield
6	TMDS Data1–	TMDS negative data 1
7	TMDS Data0+	TMDS positive data 0
8	TMDS Data0 Shield	TMDS data 0 shield
9	TMDS Data0–	TMDS negative data 0
10	TMDS Clock+	TMDS positive clock
11	TMDS Clock Shield	TMDS clock shield
12	TMDS Clock–	TMDS negative clock
13	NC	Not connected
14	NC	Not connected
15	SCL	I ² C serial clock for data display channel (DDC)
16	SDA	I ² C serial data line for DDC
17	DDC/CEC/ARC/HEC Ground	Grounds for DDC, CEC, ARC, and HEC
18	+5V	5V supply (maximum 0.05A)
19	Hot Plug Detect	Hot plug detection pin

USB Connectors

The USB connectors support USB 2.0. You can use the USB connectors to connect USB-compliant devices to Reddy, including external memory, mouse, and keyboard. International USB 2.0 standards are applied.

Table A–9 USB connector data

Type	USB, female
Manufacturer P/N	FCi 73725-01 I0BLF
Eddyfi P/N	MACN4038

Table A–10 USB connector pinout

Pin	Signal	Description
1	VCC	5V supply
2	D–	Data–
3	D+	Data+
4	GND	Ground

3.5 mm Audio Connector

Table A–11 Audio connector data

Type	3.5 mm audio jack, female
Manufacturer P/N	CUI SJ1-3514-SMT-TR
Eddyfi P/N	MACN4048

Table A–12 Audio connector pinout

Pin	Signal	Description
1	GND	Ground
2	Left	Left channel
3	Right	Right channel

Appendix B

Using the Optional Harness

Adjusting the Harness

Harnessing Reddy® requires a number of specific adjustments so that you feel comfortable wearing the harness.

Adjusting the Harness to your Body

1. Grab the harness shoulder straps and slip it over your shoulders as you would a jacket.

Figure B-1 Slipping the harness on



2. Verify the fit of the harness.
Visualize working with Reddy before making any adjustments to the shoulder straps and height of the belt.
3. Slip out of the harness.

4. Use the underarm straps and shoulder blade rings to adjust the fit of your shoulder straps. You may need to perform this adjustment several times to get the proper fit.

Figure B-2 Adjusting the shoulder straps



5. Use the back and side belt straps to adjust the height of the harness' belt to suit your body type. You may need to perform this adjustment several times to get the proper fit.

Note

Your belt's height determines the lowest position of Reddy. Adjust this height so that the display of the instrument is easy to see—for that, the belt could end up higher than your hips.

Figure B-3 Adjusting the belt's height



6. Once your belt and shoulder straps are adjusted, clip and tighten the chest straps.

Figure B-4 Securing the chest straps



7. Secure the belt around your waist, according to the height you have adjusted it.

Figure B-5 Securing the belt



8. Make sure that the harness fits snugly.
9. Make sure that the harness' shoulder anchor straps are loose.

Figure B-6 Shoulder anchor straps



10. Unfasten the two straps at each end of the shoulder anchor straps. Place them within hands reach. You will need them.

Figure B-7 Unfastening the straps



11. Sit down.
12. Place Reddy horizontally in your lap.
13. Slip the looped portion of the strap removed above in the hook of one of the two upper Reddy bumpers, as illustrated.

Figure B-8 Sliding strap loop through bumper hook



14. Slip the clip through the strap hoop, and then pull to tighten into place, as illustrated.

Figure B-9 Securing anchor strap



15. Repeat the previous two steps for the opposite upper bumper.

Note

You can also secure the straps to the bumpers in a more elegant and less easy-to-remove fashion, as illustrated here.

Figure B-10 Alternative method of securing anchor strap to bumper



16. Locate the anchor strap on the harness' belt.

Figure B-11 Anchor strap on harness belt



17. Open the battery compartment door and slip the male buckle of the anchor strap, as illustrated.

Figure B-12 Slipping male buckle through bumper



18. Mate the male buckle to its female counterpart.

Figure B-13 Mating battery compartment side anchor strap



19. Close and secure the battery compartment door.

Figure B-14 Closing battery compartment door.



20. Repeat the procedure for the opposite belt anchor strap (no door to open).

21. Adjust the length of the anchor straps until comfortable.

22. Mate the left male buckle of the shoulder anchor strap to its female counterpart.

Figure B-15 Mating shoulder anchor strap



23. Repeat for the opposite shoulder anchor strap.

24. Tighten each shoulder anchor straps to achieve the desired view angle for Reddy.

Figure B-16 Tightening shoulder anchor straps



Note

Use the belt strap to hook your probe's cable.

Figure B-17 Belt-slinging probe cable





www.eddyfi.com